



Trade Catalogue





1979 Cetinkaya Pano was formed at the field of electrics and electronics. Cetinkaya grew and developed during these passing 46 years in production, design, marketing and export by increasing its market-share day by day.

Cetinkaya attached importance to the quality factor in its products and targeted first of all customer satisfaction. Cetinkaya produces a wide range of products, including metal enclosures, wiring ducts, stabilizer, plastic junction boxes, plastic boards, plastic and polyester distribution boards and meter boards.

Besides its own production, CETINKAYA PANO is the distributor of GEWISS and LEGRAND , which are globally well-known brands in the sector.

www.cetinkayapano.com

COMPANY PROFILE

The Company:

Cetinkaya , placed in İstanbul Turkey, was founded in 1979. The main activity area of Cetinkaya is the production of high quality electrical boards for professional and private use.

Cetinkaya has such a framework :

- Latest Technology in self-owned facilities occupying 55.000 m²
- Automation in production line
- Over 450 personnel experienced in their fields
- Over 5 million pieces annual production in facilities
- Import from global giants of electricity sector like Gewiss and Legrand.
- Quality Control based production in all facilities.

OUR VISION IS;

To be an entrepreneurial and innovative company, by renewing our production facilities according to the newest technological developments, to adapt to the changing trends of the sector, to satisfy the customer needs with our various distinctive and attractive designs, to increase the customer satisfaction level by taking the social and ethical values into consideration.

OUR MISSION IS;

To base our corporate structure on hard-working, dynamic, honest people who are in harmony with our corporate core values, to maintain our corporate continuity, to maintain the satisfaction of our stakeholders by establishing an optimal commercial atmosphere, to optimize the production process by making use of new and technological equipments. to satisfy different customer's needs by being different in the market through our intensive product diversification.

CETINKAYA owns one of the most technological automation lines in the field, to be able to supply to customers in time while maintaining high quality in its products.

The Products:

46 years experience leads to a huge portfolio of products. The product range consists of plastic, metal, polyester boards and boxes, as well as manhole boxes and covers.

Product categories are listed below:

- **PLASTIC BOARDS AND BOXES:** Plastic distribution boxes, watertight boards and junction boxes, as well as Marine and Telephone Boards are included in this group. The raw material used is ABS RAL 7035 with high IP degrees to increase the durability of the products.
- **METAL BOARDS :** Metal Boards are wall mounted or for floor installation in different types. They differ in their covers as blank or transparent. Different roof preferences and needs can also be satisfied. Mounted metal boards for floor installation are also supplied with different possibilities of different brands sockets with flexible price alternatives.
- **POLYESTER (GRP) BOARDS:** Polyester Boards are manufactured in polyester reinforced with fiber glas. They are especially resistant against corrosion, can be installed on the wall, on the ground or on other supporting bases. Furthermore, they can be adjusted to meter boards with special inside accessories. Special water meter is also included in this product category.

- **MANHOLE BOXES:** Cetinkaya introduced its newest product serie,namely; the thermoplastic manhole boxes and covers to the market. These boxes are used in electrics, for the passage of drainage water and in the area of telecommunication. The manhole boxes can be produced in various types and dimensions according to diff erent preferences of customers.They may be ordered in dimensions of 200x200x200, 300x300x300, 400x400x400, 550x550x500, 360x260x320; with cover alternatives like gridded or blank; green or grey; and with 4,6 or 10 ways out,which is a special design of this product.

CETINKAYA products are one of the most reliable products in the sector and CETINKAYA increases its market share in Turkey, as well as in Balkans, in Western and Middle Europe, Middle and North Africa and Asia. The reliability of the products is based on the certified quality, innovation, design, production technology, best quality and competitive price advantage.

Certified Quality:

Cetinkaya underlines the importance of quality in its production and supports its attribute with different quality certificates.

The latest quality certifi cates are listed below:

- Declaration of Conformity CE for all the products.
- Certificate of Conformity to Turkish Standarts
- Certificate of Registration for TS EN ISO 9001:2008
- GOST-R Certificate
- UL Certificate

R&D Department:

The Research and Development department of CETINKAYA is composed of highly experienced professionals who are working with high precision in their field. There is also a mould building facility inside the factory facilitating innovative designs in our products.

Automated Production:

CETINKAYA makes considerable investments in automation technologies to develop its production facilities day by day and to increase the customer satisfaction. Time, quality and price are the most important factors which CETINKAYA’s production is based on.

Goals and Objectives:

Goals and Objectives of Cetinkaya are always one step further of its competitors. By developing the production facilities and by following the latest Technologies, CETINKAYA keeps up with the world of innovation and increases its market share throughout the world. Today, Cetinkaya exporting to 100 countries, aims to increase its export volume with its reliable company profile.



OUR PRODUCTS GROUPS;



CP BOX METAL



CP BOX PLASTIC



CP BOX POLYESTER

OUR PRODUCTS GROUPS;



CP BOX STABILIZER



VENTILATION - ACCESORIES



**CP CABLING ALIMINIUM
PRODUCT**



**WE ARE AROUND THE
WORLD, EVERYWHERE!**

CP BOX PLASTIC

CP BOX METAL

CP BOX POLYESTER

ACCESORIES

VENTILATION SYSTEMS

CP CABLING ALIMINIUM PRODUCTS

CP LIGHTING

CP STABILIZER

11-43

44-68

69-72

73-80

81-96

97-106

107-112

113-119



**CP BOX PLASTIC
PRODUCT RANGE**



JUNCTION BOXES

with cable gland

Technical Characteristic

- Ral 7035 Grey
- Impact Resistant
- IK 10
- With Press-fit Cover
- Made of ABS
- Multiple Size Cable Sleeve
- Operating Temperature: -25°C to +60°C
- Glow wire Test 650°C



Junction Boxes - With press fit cover

Code	Dimension (WxHxD)	Pack
CP 1036	Ø 70x40	60
CP 1037	Ø 85x45	40
CP 1038	80x80x40	40



Junction Boxes - With stainless steel screw

Code	Dimension (WxHxD)	Pack
CP 1039	80x120x50	22
CP 1040	100x100x50	18
CP 1051	150x110x70	9
CP 1055	110x110x70	12
CP 1072	150x150x70	10



Junction Boxes - With plastic screw

Code	Dimension (WxHxD)	Pack
CP 1052	190x145x80	10
CP 1053	250x200x90	12
CP 1054	310x230x130	6
CP 1056	400x480x130	4



Junction Boxes - With stainless steel screw

Code	Dimension (WxHxD)	Pack
CP 1359	80x120x120	35
CP 1360	100x100x120	36
CP 1361	150x110x140	16



Junction Boxes - With plastic screw

Code	Dimension (WxHxD)	Pack
CP 1362	190x145x140	10
CP 1363	250x200x160	6
CP 1364	310x230x180	6

JUNCTION BOXES

with blank sides

Technical Characteristic

- Ral 7035 Grey
- Impact Resistant
- IK 10
- With Press-fit Cover
- Made of ABS
- Screwed Cover
- Operating Temperature: -25°C to +60°C
- Smooth Sides and Plain Blank Cover
- Glow wire Test 650°C



Junction Boxes - With stainless steel screw



Code	Dimension (WxHxD)	Pack
CP 1029	80x120x50	22
CP 1030	100x100x50	18
CP 1032	150x150x70	10
CP 1035	110x110x70	12
CP 1041	150x110x70	9
CP 1047	125x230x80	16
CP 1048	125x350x80	20
CP 1049	125x460x80	8



Junction Boxes - With plastic screw



Code	Dimension (WxHxD)	Pack
CP 1042	190x145x80	10
CP 1043	250x200x90	12
CP 1044	310x230x130	6
CP 1045	400x300x130	6
CP 1046	400x480x130	4



Junction Boxes - With stainless steel screw



Code	Dimension (WxHxD)	Pack
CP 1059	80x120x120	35
CP 1060	100x100x120	36
CP 1061	150x110x140	16
CP 1065	230x125x120	15



Junction Boxes - With plastic screw



Code	Dimension (WxHxD)	Pack
CP 1062	190x145x140	10
CP 1063	250x200x160	6
CP 1064	310x230x180	6

JUNCTION BOXES

with knock-outs

Technical Characteristic

- Ral 7035 Grey
- Impact Resistant
- IK 10
- With Press-fit Cover
- Made of ABS
- Knock-out Entries
- Operating Temperature: -25°C to +60°C
- Glow wire Test 650°C



Junction Boxes - With press fit Cover

Code	Dimension (WxHxD)	Pack
CP 1020	90x43x40	456
CP 1021	75x75x40	280
CP 1022	85x85x40	224

* Made of cover and Base ar PP/PS



Junction Boxes - With press fit Cover

Code	Dimension (WxHxD)	Pack
CP 1236	Ø 70x40	60
CP 1237	Ø 85x45	40
CP 1238	80x80x40	40



Junction Boxes - With plastic screw

Code	Dimension (WxHxD)	Pack
CP 1235	110x110x70	10
CP 1239	80x120x50	22
CP 1240	100x100x50	18
CP 1251	150x110x70	9
CP 1232	150x150x70	10
CP 1252	190x145x80	10
CP 1253	250x200x90	12
CP 1254	310x230x130	6

■ Stainless steel screw / IP54



Junction Boxes - With plastic screw

Code	Dimension (WxHxD)	Pack
CP 1259	80x120x120	35
CP 1260	100x100x120	36
CP 1261	150x110x140	16
CP 1262	190x145x140	10
CP 1263	250x200x160	6
CP 1264	310x230x180	6

■ Stainless steel screw / IP54

JUNCTION BOXES

with knock outs

Technical Characteristic

- Ral 7035 Grey
- Impact Resistant
- IK 10
- Made of ABS; Cover is Made of Polycarbonate
- Knock-out Entries
- Operating Temperature: -25°C to +60°C
- Glow wire Test 650°C



Transparent - With Plastic Screw



Code	Dimension (WxHxD)		Pack
CP 1451	150x110x70	■	9
CP 1432	150x150x70	■	10
CP 1452	190x145x80		10
CP 1453	250x200x90		12
CP 1454	310x230x130		6

■ Stainless steel screw / IP54



Transparent - With Plastic Screw



Code	Dimension (WxHxD)		Pack
CP 1471	150x110x140	■	16
CP 1472	190x145x140		10
CP 1473	250x200x160		6
CP 1474	310x230x180		6

■ Stainless screw / IP54



Mounting Plate

Code	Dimension (WxHxD)	Pack
CP 2042	190x145	10
CP 2043	250x200	10
CP 2044	310x230	10
CP 2045	400x300	10
CP 2046	400x480	5

JUNCTION BOXES

with blank sides

Technical Characteristic

- Ral 7035 Grey
- Impact Resistant
- IK 10
- Made of ABS; Cover is Made of Polycarbonate
- Multiple Size Cable Sleeve
- Operating Temperature: -25°C to +60°C
- Glow wire Test 650°C



Transparent - With Plastic Screws

Code	Dimension (WxHxD)	Pack
CP 1132	150x150x70	10
CP 1141	150x110x70	10
CP 1142	190x145x80	10
CP 1143	250x200x90	12
CP 1144	310x230x130	6
CP 1145	400x300x130	6
CP 1146	400x480x130	4

■ Stainless screw / IP54



Transparent - With Plastic Screws

Code	Dimension (WxHxD)	Pack
CP 1161	150x110x140	16
CP 1162	190x145x140	10
CP 1163	250x200x160	6
CP 1164	310x230x180	6

■ Stainless screw / IP54



Mounting Plate

Code	Dimension (WxHxD)	Pack
CP 2042	190x145	10
CP 2043	250x200	10
CP 2044	310x230	10
CP 2045	400x300	10
CP 2046	400x480	5

JUNCTION BOXES

with cable gland

Technical Characteristic

- Ral 7035 Grey
- Impact Resistant
- IK 10
- ABS - PC
- Multiple Size Cable Sleeve
- Operating Temperature: -25°C to +60°C
- Glow wire Test 650°C



Transparent - With Plastic Screw



Code	Dimension (WxHxD)		Pack
CP 1151	150x110x70	■	9
CP 1172	150x150x70	■	10
CP 1152	190x145x80		10
CP 1153	250x200x90		12
CP 1154	310x230x130		6
CP 1156	400x480x130		4

■ Stainless steel screw / IP54



Transparent - With Plastic Screw



Code	Dimension (WxHxD)		Pack
CP 1461	150x110x140	■	16
CP 1462	190x145x140		10
CP 1463	250x200x160		6
CP 1464	310x230x180		6

■ Stainless screw / IP54



Flush Mounting



Code	Dimension (WxHxD)		Pack
CP 1801	85x85x45		96
CP 1802	100x100x45		76
CP 1803	130x130x55		36
CP 1804	160x160x65		20
CP 1805	200x200x70		12
CP 1806	192x152x70		40
CP 1807	294x152x70		30
CP 1808	392x152x70		30

DISTRIBUTION BOARDS

flush mounting



Technical Characteristic

- From 8 to 90 Modules
- Ergonomic opening / closing system
- Precise design with blank or smoked door
- Operating Temperature; -25 to +60C
- Hinged door which opens more than 180°
- Ready to install the terminal blocks for neutral and earth connection

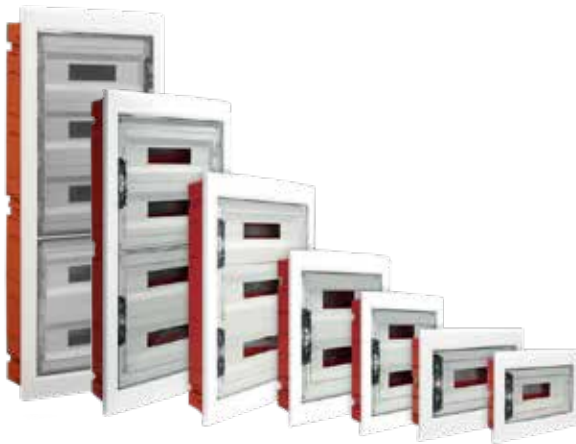

Smoked Transparent Door

Code	Din Modules	Pack
CP 10908	8 Modules	20
CP 10912	12 Modules	12
CP 10918	18 Modules	10
CP 10924-1	24 Modules	10
CP 10924	24 (12x2) Modules	10
CP 10936	36 (12x3) Modules	10
CP 10936-1	36 (18x2) Modules	10
CP 10954	54 (18x3) Modules	4
CP 10972	72 (18x4) Modules	4
CP 10990	90 (18x5) Modules	1

■ *Unremovable cover system



Blank Door

Code	Din Modules	Pack
CP 12908	8 Modules	20
CP 12912	12 Modules	12
CP 12918	18 Modules	10
CP 12924-1	24 Modules	10
CP 12924	24 (12x2) Modules	10
CP 12936	36 (12x3) Modules	10
CP 12936-1	36 (18x2) Modules	10
CP 12954	54 (18x3) Modules	4
CP 12972	72 (18x4) Modules	4
CP 12990	90 (18x5) Modules	1

■ *Unremovable cover system

Complementary Items

Code	Din Modules	Pack
CP 12011	Terminal Blocks - 12M	1
CP 12012	Terminal Blocks - 18M	1



DISTRIBUTION BOARDS

flush mounting



Technical Characteristic

- From 8 to 72 Modules
- Ergonomic opening / closing system
- Precise design with blank or smoked door
- Operating Temperature; -25 to +60C
- Hinged door which opens more than 180°
- Ready to install the terminal blocks for neutral and earth connection



Toner Black - Smoked Transparent

Code	Din Modules	Pack
CP 10908 B	8 Modules	20
CP 10912 B	12 Modules	12
CP 10918 B	18 Modules	10
CP 10924 B	24 (12x2) Modules	10
CP 10924-1 B	24 Modules	10
CP 10936 B	36 (12x3) Modules	10
CP 10936-1 B	36 (18x2) Modules	10
CP 10954 B	54 (18x3) Modules	4
CP 10972 B	72 (18x4) Modules	4
CP 10990 B	90 (18x5) Modules	1

■ *Unremovable cover system



Toner Black - Blank Door

Code	Din Modules	Pack
CP 12908 B	8 Modules	20
CP 12912 B	12 Modules	12
CP 12918 B	18 Modules	10
CP 12924-1 B	24 Modules	10
CP 12924 B	24 (12x2) Modules	10
CP 12936 B	36 (12x3) Modules	10
CP 12936-1 B	36 (18x2) Modules	10
CP 12954 B	54 (18x3) Modules	4
CP 12972 B	72 (18x4) Modules	4
CP 12990 B	90 (18x5) Modules	1

■ *Unremovable cover system



Complementary Items

Code	Din Modules	Pack
CP 12011	Terminal Blocks - 24M	1
CP 12012	Terminal Blocks - 36M	1

DISTRIBUTION BOARDS

flush mounting



Technical Characteristic

- From 8 to 72 Modules
- Ergonomic opening / closing system
- Precise design with blank or smoked door
- Operating Temperature; -25 to +60C
- Hinged door which opens more than 180°
- Ready to install the terminal blocks for neutral and earth connection



CP 10954-P1



CP 10972-P1



CP 14972-P1



CP 14990-P1



CP 12936-1-P1



CP 12936-P1



CP 12954-P1



CP 12972-P1



Smoked Transparent Door-Plastic Body-weak current

Code	Din Modules	Pack
CP 10936-1-P1	18 (18x1) Modules	10
CP 10936-P1	24 (12X2) Modules	10
CP 10954-P1	36 (18x2) Modules	4
CP 10972-P1	54 (18x3) Modules	4
CP 14972-P1	54 (18x3) Modules Blank & Transparent Door	4
CP 14990-P1	54 (18x3) Modules Blank & Transparent Door	1

Blank Door-Plastic Body-weak current

Code	Din Modules	Pack
CP 12936-1-P1	18 (18x1) Modules	10
CP 12936-P1	24 (12X2) Modules	10
CP 12954-P1	36 (18x2) Modules	4
CP 12972-P1	54 (18x3) Modules	4

DISTRIBUTION BOARDS

flush mounting



Technical Characteristic

- From 36 to 72 Modules
- Ergonomic opening / closing system
- Precise design with blank and smoked door
- Operating Temperature; -25 to +60C
- Hinged door which opens more than 180
- Ready to install the terminal blocks for neutral and earth connection



CP 10936-M2



Smoked Transparent Door-Metal Body

Code	Din Modules	Pack
CP 10936-M2	36 (12x3) Modules	10
CP 10954-M2	54(18X3) Modules	4
CP 10972-M2	72 (18x4) Modules	4



CP 12954-M2

Blank Door-Metal Body

Code	Din Modules	Pack
CP 12936-M2	36 (12x3) Modules	10
CP 12954-M2	54(18X3) Modules	4
CP 12972-M2	72 (18x4) Modules	4



CP 14972-M1

Smoked Transparent-Metal Body-weak current

Code	Din Modules	Pack
CP 10936-M1	24 (12x2) Modules	10
CP 10954-M1	36(18X2) Modules	4
CP 10972-M1	54 (18x3) Modules	4
CP 14972-M1	54 (18x3) Modules Blank & Transparent Door	4



CP 12972-M1

Blank Door-Metal Body-weak current

Code	Din Modules	Pack
CP 12936-M1	24 (12x2) Modules	10
CP 12954-M1	36(18X2) Modules	4
CP 12972-M1	54 (18x3) Modules	4

DISTRIBUTION BOARDS

▶ surface mounting



Technical Characteristic

- From 8 to 72 Modules
- Ergonomic opening / closing system
- Precise design with blank or smoked door
- Hinged door which opens more than 180°
- Operating Temperature; -25 to +60C
- Ready to install the terminal blocks for neutral and earth connection



Smoked Transparent Door

Code	Din Modules	Pack
CP 30908	8 Modules	20
CP 30912	12 Modules	12
CP 30924-1	24 Modules 	10
CP 30924	24 (12x2) Modules	10
CP 30936	36 (12x3) Modules	10
CP 30936-1	36 (18x2) Modules	10
CP 30954	54 (18x3) Modules	4
CP 30972	72 (18x4) Modules	4

 *Unremovable cover system



Blank Door

Code	Din Modules	Pack
CP 32908	8 Modules	20
CP 32912	12 Modules	12
CP 32924-1	24 Modules 	10
CP 32924	24 (12x2) Modules	10
CP 32936	36 (12x3) Modules	10
CP 32936-1	36 (18x2) Modules	10
CP 32954	54 (18x3) Modules	4
CP 32972	72 (18x4) Modules	4

 *Unremovable cover system



Complementary Items

Code	Din Modules	Pack
CP 12011	Terminal Blocks - 24M	1
CP 12012	Terminal Blocks - 36M	1

DISTRIBUTION BOARDS

▶ surface mounting



Technical Characteristic

- From 8 to 72 Modules
- Ergonomic opening / closing system
- Precise design with blank or smoked door
- Hinged door which opens more than 180°
- Operating Temperature; -25 to +60C
- Ready to install the terminal blocks for neutral and earth connection



Toner Black - Smoked Transparent

Code	Din Modules	Pack
CP 30908 B	8 Modules	20
CP 30912 B	12 Modules	12
CP 30924 B	24 (12x2) Modules	10
CP 30924-1 B	24 Modules 	10
CP 30936 B	36 (12x3) Modules	10
CP 30936-1 B	36 (18x2) Modules	10
CP 30954 B	54 (18x3) Modules	4
CP 30972 B	72 (18x4) Modules	4

 *Unremovable cover system



Toner Black - Blank Door

Code	Din Modules	Pack
CP 32908 B	8 Modules	20
CP 32912 B	12 Modules	12
CP 32924 B	24 (12x2) Modules	10
CP 32924-1 B	24 Modules 	10
CP 32936 B	36 (12x3) Modules	10
CP 32936-1 B	36 (18x2) Modules	10
CP 32954 B	54 (18x3) Modules	4
CP 32972 B	72 (18x4) Modules	4

 *Unremovable cover system

DISTRIBUTION BOARDS

▶ surface mounting



Technical Characteristic

- Ral 91682 soft white
- Impact Resistant
- Degree of Protection IP 40
- Manufactured in polycarbonate raw material
- Including terminal block
- Hinged door which opens more than 90°
- Smoked Transparent Door
- Choice for Blank Door
- Resistant to Chemical and weathering agents



CPBenefit Series



Surface Distribution Boards

Code	Din Modules	Pack
CP 11905	5 Modules	24
CP 11908	8 Modules	24
CP 11912	12 Modules	12
CP 11924	24 Modules	12
CP 11945	45 Modules	10



Flush Distribution Boards

Code	Din Modules	Pack
CP 1905	5 Modules	24
CP 1908	8 Modules	24
CP 1912	12 Modules	12
CP 1924	24 Modules	12
CP 1936	36 Modules	10



Distribution Boards - With Cover Version

Code	Din Modules	Pack
CP 01011	1 Module	140
CP 01012	2 Modules	100
CP 01034	4 Modules	56
CP 01035	8 Modules	28

DISTRIBUTION BOARDS

▶ surface mounting



Technical Characteristic

- From 4 to 42 Modules
- Easy and Fast Installation
- Wide Space for the cabling
- Pre-Drilled entries for an easy installation
- Ready to install the terminal blocks
- 1/4 turn screws
- Blank and Transparent door



CP 3902



CP 3904

Smoked Transparent Door

Code	Din Modules	Pack
CP 3902	4 Modules	30
CP 3904	4 Modules	17
CP 3908	8 Modules	9
CP 3912	12 Modules	7
CP 3926	26 (13x2) Modules	5
CP 3942	42 (14x3) Modules	4



CP 3900

Accessories

Code	Description	Pack
CP 3900	Metal Key for CP39XX range	1
CP 3901	Terminal Bar for CP39XX range	1



CP 3901



DISTRIBUTION BOARDS

▶ surface mounting



Technical Characteristic

- From 5 to 72 Modules
- Easy and Fast Installation
- Ral 7035 Grey
- Degree of Protection IP 65



CP 20905



Smoked Transparent Door

Code	Din Modules
CP 20905	5 Modules
CP 20908	4 Modules



CP 20908



Smoked Transparent Door

Code	Din Modules
CP 20912	12 Modules
CP 20924	24 (12x2) Modules
CP 20936	36 (12x3) Modules
CP 20954	54 (18x3) Modules
CP 20972	72 (18x4) Modules

WATERTIGHT BOARDS

▶ blank door



Technical Characteristic

Watertight Boards in Thermoplastic Material for Protection Devices for Residential, Commercial and Industrial Areas.

- Ral 7035 Grey
- ABS Material
- Halogen Free
- IK 10 - GWT 650°C
- Triangle Lock-Key
- PUR Material for High Quality Sealing
- Included 1mm. Galvanized Mounting Plate
- Included Wall Fixing Bracket
- Operating Temperature , -25 to +60C



Watertight Boards - Blank Door

Code	Dimension (WxHxD)	No. Locks	Pack
CP 5022	180x240x120	1	1
CP 5001	210x280x130	1	1
CP 5010	250x300x140	1	1
CP 5002	250x330x130	1	1
CP 5002 D	250x350x150	1	1
CP 5021	300x350x165	1	1
CP 5003	300x400x165	2	1
CP 5003 D	300x400x195	2	1
CP 5007	350x500x195	2	1
CP 5004	400x500x175	2	1
CP 5004 D	400x500x240	2	1
CP 5005	400x600x200	2	1
CP 5006 Y	500x700x245	2	1

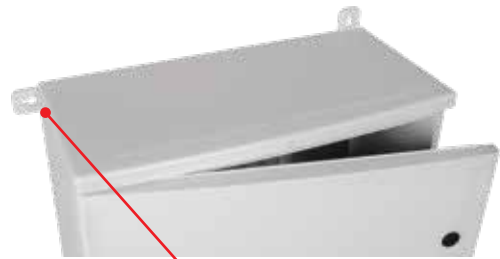

Mounting Accessory

Watertight Boards - Blank Door

Code	Dimension (WxHxD)	No. Locks	Pack
CP 5006	500x700x245	2	1
CP 5008	500x600x230	2	1
CP 5009	600x800x265	3	1
CP 5023	750x1000x300	1	1

- * Reversible door direction
- * Adjustable mounting plate

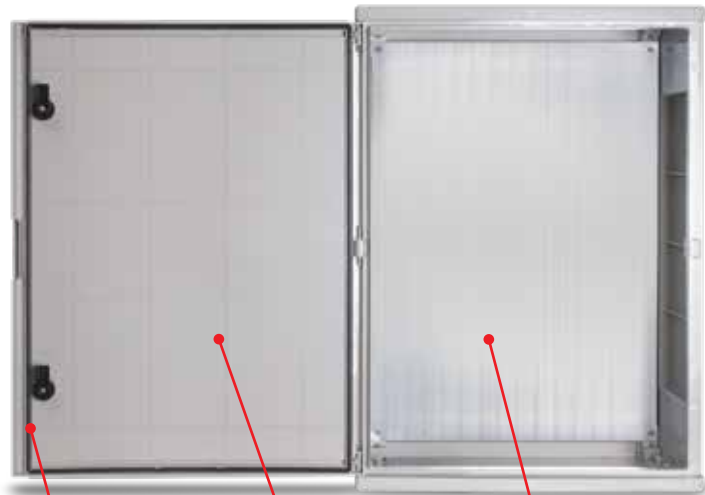

Pur material

Reversible Door Direction

Adjustable Mounting Plate (3 steps)

Accessory

Code	Description	Pack
CP 5000	Lock for Watertight Boards (2 keys)	1
CPMA 50	Mounting Accessory for Pole	1



WATERTIGHT BOARDS

transparent door



Technical Characteristic

Watertight Boards in Thermoplastic Material for Protection Devices for Residential, Commercial and Industrial Areas.

- Ral 7035 Grey
- ABS-PC Material
- Halogen Free
- IK 10 - GWT 650°C
- Triangle Lock-Key
- PUR Material for High Quality Sealing
- Included 1mm. Galvanized Mounting Plate
- Included Wall Fixing Bracket
- Operating Temperature , -25 to +60C



Watertight Boards - Transparent Door

Code	Dimension (WxHxD)	No. Locks	Pack
CP 5032	180x240x120	1	1
CP 5011	210x280x130	1	1
CP 5020	250x300x140	1	1
CP 5012	250x330x130	1	1
CP 5012 D	250x350x150	1	1
CP 5031	300x350x165	1	1
CP 5013	300x400x165	2	1
CP 5013 D	300x400x195	2	1
CP 5017	350x500x195	2	1
CP 5014	400x500x175	2	1
CP 5014 D	400x500x240	2	1
CP 5015	400x600x200	2	1
CP 5016 Y	500x700x245	2	1



Watertight Boards - Transparent Door

Code	Dimension (WxHxD)	No. Locks	Pack
CP 5016	500x700x245	2	1
CP 5018	500x600x230	2	1
CP 5019	600x800x265	3	1



Safety Lock with Handle

Code	Description	Pack
CP 5000	Lock for Watertight Boards (2 keys)	1

WATERTIGHT BOARDS

with roof



Technical Characteristic

Watertight Boards in Thermoplastic Material for Protection Devices for Residential, Commercial and Industrial Areas.

- Ral 7035 Grey
- ABS-PC Material
- Halogen Free
- IK 10 - GWT 650°C
- Triangle Lock-Key
- PUR Material for High Quality Sealing
- Included 1mm. Galvanized Mounting Plate
- Included Wall Fixing Bracket
- Operating Temperature , -25 to +60C



Blank Door - With Roof

Code	Dimension (WxHxD)	No. Locks	Pack
CP 5603	300x400x165	2	1
CP 5604	400x500x175	2	1
CP 5605	400x600x200	2	1
CP 5606	500x700x245	2	1
CP 5607	350x500x195	2	1
CP 5608	500x600x230	2	1
CP 5609	600x800x265	3	1
CP 5610	750x1000x300	3	1



Transparent Door - With Roof

Code	Dimension (WxHxD)	No. Locks	Pack
CP 5613	300x400x165	2	1
CP 5614	400x500x175	2	1
CP 5615	400x600x200	2	1
CP 5616	500x700x245	2	1
CP 5617	350x500x195	2	1
CP 5618	500x600x230	2	1
CP 5619	600x800x265	3	1



Watertight Board Roof

Code	Dimension (WxHxD)	Pack
Y.SAP0005603	300x165	1
Y.SAP0005604	400x175	1
Y.SAP0005605	400x200	1
Y.SAP0005606	500x245	1
Y.SAP0005607	350x195	1
Y.SAP0005608	500x220	1
Y.SAP0005609	600x260	1

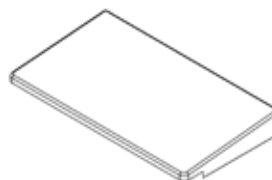

Safety Lock with Handle

Code	Description	Pack
CP 5000	Lock for Watertight Boards (2 keys)	1



WATERTIGHT ASA BOARD

blank door



Technical Characteristic

- Made of ASA (Acrylonitrile Styrene Acrylate)
- It's perfect usage for outdoor applications and for high ultraviolet resistance
- Resistant to UV
- No color change at least in 10 years
- Triple lock system
- IK 10
- RAL 9011 - Beige
- Operating Temperature , -25 to +80C
- PUR Material for High Quality Sealing
- Included 1 mm galvanized mounting plate



Watertight ASA Boards - Blank Door

Code	Dimension (WxHxD)	No. Locks	Pack
CPA 5002	250x330x130	1	1
CPA 5003	300x400x165	2	1
CPA 5004	400x500x175	2	1
CPA 5005	400x600x200	2	1
CPA 5006	500x700x245	2	1
CPA 5009	600x800x260	3	1
CPA 5023	750x1000x300	1	1

■ Triple lock system

Complementary Items for CP 5023

Code	Description	Pack
CP 5023R	Roof for CP 5023	1
CP 5023B	Base for CP 5023	1
CP 5023W	Wall fixing bracket set	1



Triple lock system



DISTRIBUTION BOARDS

with din rail fixing



Technical Characteristic

Watertight Boards in Thermoplastic Material for Protection Devices for Residential, Commercial and Industrial Areas.

- Ral 7035 Grey
- ABS-PC Material
- Halogen Free
- IK 10
- GWT 650°C
- Triangle Lock-Key
- PUR Material for High Quality Sealing
- Included Wall Fixing Bracket
- Operating Temperature , -25 to +60C



Distribution Boards - Blank Door

Code	Dimension (WxHxD)	Din Modules	Pack
CP 5100	180x240x120	6M(1x6)	1
CP 5101	210x280x130	16M(2x8)	1
CP 5102	250x330x130	18M(2x9)	1
CP 5103	300x400x165	24M(2x12)	1
CP 5104	400x500x175	51M(3x17)	1
CP 5105	400x600x200	68M(4x17)	1
CP 5106	500x700x245	88M(4x22)	1
CP 5107	350x500x195	45M(3x15)	1
CP 5108	500x600x230	66M(3x22)	1
CP 5109	600x800x265	100M(4x25)	1



Distribution Boards - Transparent Door

Code	Dimension (WxHxD)	Din Modules	Pack
CP 5110	180x240x130	6M(1x6)	1
CP 5111	210x280x130	16M(2x8)	1
CP 5112	250x330x130	18M(2x9)	1
CP 5113	300x400x165	24M(2x12)	1
CP 5114	400x500x175	51M(3x17)	1
CP 5115	400x600x200	68M(4x17)	1
CP 5116	500x700x245	88M(4x22)	1
CP 5117	350x500x195	45M(3x15)	1
CP 5118	500x600x230	66M(3x22)	1
CP 5119	600x800x265	100M(4x25)	1



Complementary Items

Panels With Din Rail Fixing

Code	Description	Pack
CP 4120	6M - For Boards - 180x240mm.	1
CP 4121	16M - For Boards - 210x280mm.	1
CP 4122	18M - For Boards - 250x330mm.	1
CP 4123	24M - For Boards - 300x400mm.	1
CP 4124	51M - For Boards - 400x500mm.	1
CP 4125	68M - For Boards - 400x600mm.	1
CP 4126	88M - For Boards - 500x700mm.	1
CP 4127	45M - For Boards - 350x500mm.	1
CP 4128	66M - For Boards - 500x600mm.	1
CP 4129	100M - For Boards - 600x800mm.	1



DISTRIBUTION BOARDS

for metering installation



For Metering Installation

Code	Dimension (WxHxD)	Din Modules	Pack
CP 5201	250x330x130	1 Monophase Meter , 2 MCB / Blank Door	1
CP 5202	300x400x165	1 Monophase Meter , 15 MCB / Blank Door	1
CP 5203	400x500x175	1 Triphase Meter , 6 MCB / Blank Door	1
CP 5204	400x600x200	1 Triphase Meter , 20 MCB / Blank Door	1
CP 5211	250x330x130	1 Monophase Meter , 2 MCB / Transparent Door	1
CP 5212	300x400x165	1 Monophase Meter , 15 MCB / Transparent Door	1
CP 5213	400x500x175	1 Triphase Meter , 6 MCB / Transparent Door	1
CP 5214	400x600x200	1 Triphase Meter , 20 MCB / Transparent Door	1



Distribution Board For Construction Site

Code	Dimension (WxHxD)	Description	Pack
CP 5501	400x600x200	6 socket-34 MCB / Blank Door	1
CP 5511	400x600x200	6 socket-34 MCB / Transparent Door	1
CP 5502	500x700x245	1 triph. meter, 8 socket-16 MCB / Blank Door	1
CP 5512	500x700x245	1 triph. meter, 8 socket-16 MCB / Transparent Door	1

• Height of Legs: 20 cm



For Monophase Meter

Code	Dimension (WxHxD)	Din Modules	Pack
CP 5300	170x350x100	1 Monophase Meter , 5 MCB / Smoked Door	5
CP 5301	170x350x140	1 Monophase Meter , 5 MCB / Smoked Door	4
CP 5305	170x350x100	1 Monophase Meter , 5 MCB / Blank Door	5
CP 5306	170x350x140	1 Monophase Meter , 5 MCB / Blank Door	4



For Triphase Meter

Code	Dimension (WxHxD)	Din Modules	Pack
CP 5310	240x460x132	1 Triphase Meter , 9 MCB / Smoked Door	4
CP 5315	240x460x132	1 Triphase Meter , 9 MCB / Blank Door	4

INDUSTRIAL BOXES

for industrial socket / plug installation

Technical Characteristic

- RAL 7035 Grey
- ABS - PC Material
- Halogen Free
- IK 10
- Glowwire Test 650 OC
- Operating Temperature , -25 to +60C



Industrial Box - With Angle

Code	Dimension (WxHxD)	Din Modules	Pack
CP 6000	130x240x105	6M	14
CP 6001	230x300x115	11M	6
CP 6008	250x360x125	12M - IP65	4



Industrial Box - Plain

Code	Dimension (WxHxD)	Din Modules	Pack
CP 6004	130x240x100	6M	14
CP 6005	180x360x115	6M	7
CP 6006	230x300x115	11M	6
CP 6011	130x350x105	6M	10
CP 6012	130x460x105	6M	8



Industrial Box - Plain

Code	Dimension (WxHxD)	Din Modules	Pack
new CP 6003	230x500x155	8M	4
new CP 6007	330x520x155	16M	4
new CP 6007 B	330x520x155	16M	4
CP 6010	335x330x155	16M	1

■ Codes with the letter b represent the color black.



Industrial Box - Plain

Code	Dimension (WxHxD)	Din Modules	Pack
CP 6009	330x685x155	32M	1
new CP 6013	335x520x155	16M	2
new CP 6017	335x520x155	16M / Transparent Door	2



INDUSTRIAL BOXES

▶ assembled industrial socket



Industrial Boxes With Socket

Code	Dimension (WxHxD)	Din Modules	Socket
CP 6020	130x240x105	6M	1x3P+T 16A/380V~2x2P 16A /220V
CP 6021	130x240x105	6M	1x3P+N+T 16A/380V~2x2P 16A /220V
CP 6022	130x240x105	6M	1x3P+N+T 32A/380V~2x2P 16A /220V



Industrial Boxes With Socket

Code	Dimension (WxHxD)	Din Modules	Socket
CP 6032	230x300x115	11M	2x3P+N+T 16A/380V~2x2P 16A /220V
CP 6033	230x300x115	11M	2x3P+N+T 32A/380V~2x2P 16A /220V
CP 6034	230x300x115	11M	2x3P+N+T 16A/380V~4x2P 16A /220V
CP 6035	230x300x115	11M	2x3P+N+T 32A/380V~4x2P 16A /220V



Industrial Boxes With Socket

Code	Dimension (WxHxD)	Din Modules	Socket
CP 6040	330x330x155	16M	3x3P+N+T 16A/380V~2x2P 16A /220V
CP 6041	330x330x155	16M	3x3P+N+T 32A/380V~2x2P 16A /220V
CP 6042	330x330x155	16M	3x3P+N+T 16A/380V~4x2P 16A /220V
CP 6043	330x330x155	16M	3x3P+N+T 32A/380V~4x2P 16A /220V



Industrial Boxes With Socket

Code	Dimension (WxHxD)	Din Modules	Socket
CP 6071	330x500x155	16M	3x3P+N+T 16A/380V~4x2P 16A /220V
CP 6072	330x500x155	16M	3x3P+N+T 16A/380V~3x2P+T 16A /220V
CP 6073	330x500x155	16M	3x3P+N+T 16A/380V~4x2P+T 16A /220V
CP 6074	330x500x155	16M	3x3P+N+T 32A/380V~3x2P 16A /220V
CP 6075	330x500x155	16M	3x3P+N+T 32A/380V~3x5P 16A /220V
CP 6076	330x500x155	16M	6x3P+N+T 16A/380V
CP 6077	330x500x155	16M	6x3P+N+T 32A/380V



Industrial Socket

Code	Description	Pack
CP 6901	2x16A/220V Panel Mounted Socket Outlet	40
CP 6902	2x16A/220V Panel Mounted Socket Outlet with Frame	35

INDUSTRIAL BOX WITH CABLE REELS

for construction installation



Technical Characteristic

- RAL 7035 Grey
- ABS - PC Material
- Halogen Free
- Glowwire Test 650 OC
- Operating Temperature , -25 to +60C



Construction lighting

Code	Dimension (WxHxD)	Description	Pack
CP 035	646x780x475	50W - 3000K Monophase socket 3 x 1,5 30 meter capacity	1



Industrial Box With Cable Reels- for construction installation

Code	Dimension (WxHxD)	Description	Pack
CP 6007-1	627x755x375	Basic 16M	1
CP 6007-1T	646x780x475	Cable Carrier+ Wheeled 16M 3 x 1,5 30 meter capacity	1
CP 6010-1	627x755x375	Basic 16M	1
CP 6010-1T	646x780x475	Cable Carrier+ Wheeled 16M 3 x 1,5 30 meter capacity	1



CP 6007-1



CP 6007-1T



CP 6010-1



CP 6010-1T

MANHOLE BOXES

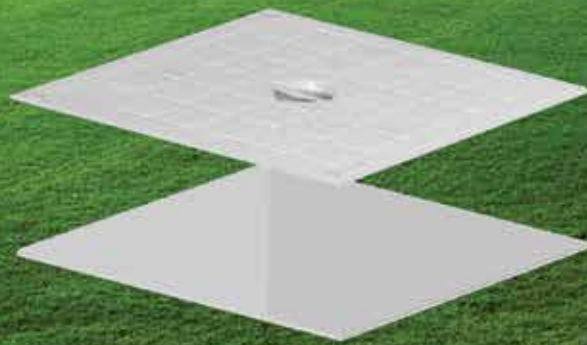

MANHOLE BOXES

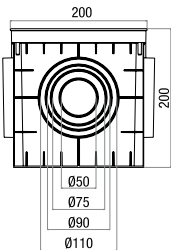

Manhole Boxes - 200x200x200

Code	Description	Pack
CP 202020	Manhole Box with cover 4 ways out	1
CP 202021	Manhole Box without cover 4 ways out	1
CP 202023	Grey blank cover	1
CP 202024	Grey Gridded cover	1
CP 202025	Green blank cover	1
CP 202026	Green Gridded cover	1

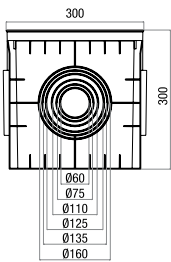

Manhole Boxes - 300x300x300

Code	Description	Pack
CP 303030	Manhole Box with cover 4 ways out	1
CP 303031	Manhole Box without cover 4 ways out	1
CP 303034	Grey blank cover	1
CP 303035	Grey Gridded cover	1
CP 303036	Green blank cover	1
CP 303037	Green Gridded cover	1

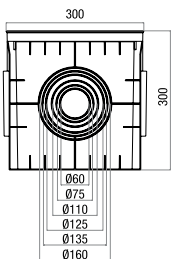

Manhole Boxes - 300x300x300

Code	Description	Pack
CP 303032	Manhole Box with cover 6 ways out	1
CP 303033	Manhole Box without cover 6 ways out	1
CP 303034	Grey blank cover	1
CP 303035	Grey Gridded cover	1
CP 303036	Green blank cover	1
CP 303037	Green Gridded cover	1

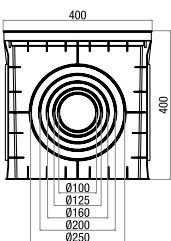

Manhole Boxes - 400x400x400

Code	Description	Pack
CP 404040	Manhole Box with cover 4 ways out	1
CP 404041	Manhole Box without cover 4 ways out	1
CP 404044	Grey blank cover	1
CP 404045	Grey Gridded cover	1
CP 404046	Green blank cover	1
CP 404047	Green Gridded cover	1

MANHOLE BOXES

Manhole Boxes - 400x400x400

Code	Description	Pack
CP 404042	Manhole Box with cover 6 ways out	1
CP 404043	Manhole Box without cover 6 ways out	1
CP 404044	Grey blank cover	1
CP 404045	Grey Gridded cover	1
CP 404046	Green blank cover	1
CP 404047	Green Gridded cover	1

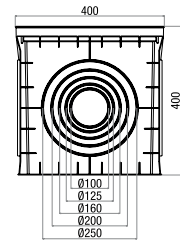

Manhole Boxes - 500x500x500

Code	Description	Pack
CP 505050	Manhole Box with cover 10 ways out	1
CP 505053	Manhole Box without cover 10 ways out	1

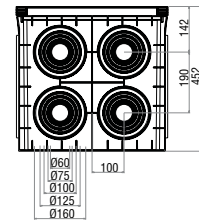

Manhole Boxes - 550x550x550

Code	Description	Pack
CP 555550	Manhole Box with cover 4 ways out	1
CP 555551	Manhole Box without cover 4 ways out	1
CP 555554	Grey blank cover	1
CP 555555	Grey Gridded cover	1
CP 555556	Green blank cover	1
CP 555557	Green Gridded cover	1

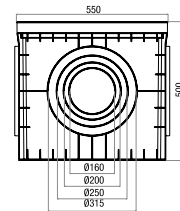

Manhole Boxes - 550x550x500

Code	Description	Pack
CP 555552	Manhole Box with blank grey cover 10 ways out	1
CP 555553	Manhole Box without cover 10 ways out	1

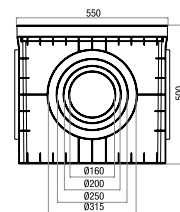
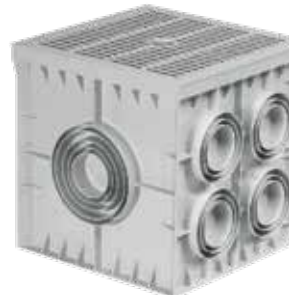

Manhole Boxes - 360x260x320

Code	Description	Pack
CP 362633	Manhole Box without cover 6 ways out	1
CP 362634	Grey blank cover	1
CP 362635	Grey Gridded cover	1
CP 362636	Green blank cover	1
CP 362637	Green Gridded cover	1

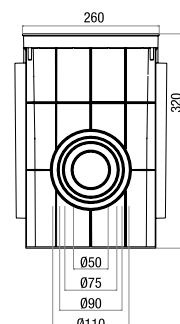

MANHOLE BOXES & COVER



Manhole Boxes

Code	Dimension (WxHxD)	Description
CP 202022	200x200x200	Thermoplastic underground manhole box
CP 303039	300x300x300	Thermoplastic underground manhole box



Manhole Boxes

Code	Dimension (WxHxD)	Description
CP 202028	200x200x30	Manhole Frame
CP 303038	300x300x40	Manhole Frame
CP 404048	400x400x45	Manhole Frame
CP 484848	480x480x40	Manhole Frame
CP 555558	550x550x65	Manhole Frame



Water Meter Board - Polyester

Code	Description	Pack
CP 672	305 x 640 x 220	1
CP 673	305 x 640 x 145	1

CABLE DUCTS

wiring ducts



We have raised our quality on worldwide standarts with UL Certificate which is one of the most reputable quality certificates in the world.

Advantageous, user-friendly and innovative, with proved quality on a worldwide scale. The CWD Wiring Ducts series is now ready to use safely in industry with  UL certification.

6mm - 4mm Rib Space Option

Due to their 6mm and 4 mm rib space design, it makes it easy to use cables of different dimensions.



The Breaking of Ribs

There are ribs lines that allow the desired ribs to be broken at angle of 60 degrees easily and without using any apparatus. In this way, you will get a comfortable and burr-free image.



The Design of Ribs Slot

Thanks to the round hole design on the ribs, you can remove your signal cables from the channel separately from other cables.

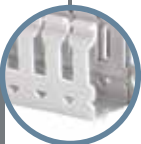
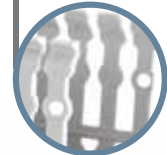

Wall Holes Design

Can be used with the cable tie thanks to additional holes on the sides.

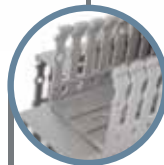

Wall Breaking

The combination of the Ducts 90 degrees corners are smooth and Burr-free integration provides. Thanks to this you will make your Panel look more elegant and rigid.

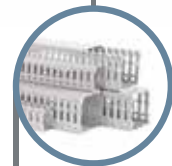

RAL 7030

Conform to the International standards.

CABLE DUCTS

wiring ducts



We have raised our quality on worldwide standarts with () UL Certificate which is one of the most reputable quality certificates in the world.

Wiring Ducts (Included Cover) (6 mm)

Code	Dimension (mm)	Colour	Pack (piece)
CWD 2525-G	25x25	RAL 7030 Grey	60x2 m.
CWD 2540-G	25x40	RAL 7030 Grey	50x2 m.
CWD 2560-G	25x60	RAL 7030 Grey	30x2 m.
CWD 2580-G	25x80	RAL 7030 Grey	24x2 m.
CWD 2510-G	25x100	RAL 7030 Grey	16x2 m.
CWD 4025-G	40x25	RAL 7030 Grey	40x2 m.
CWD 4040-G	40x40	RAL 7030 Grey	26x2 m.
CWD 4060-G	40x60	RAL 7030 Grey	18x2 m.
CWD 4080-G	40x80	RAL 7030 Grey	24x2 m.
CWD 4010-G	40x100	RAL 7030 Grey	20x2 m.
CWD 6040-G	60x40	RAL 7030 Grey	18x2 m.
CWD 6060-G	60x60	RAL 7030 Grey	24x2 m.
CWD 6080-G	60x80	RAL 7030 Grey	18x2 m.
CWD 6010-G	60x100	RAL 7030 Grey	12x2 m.
CWD 8040-G	80x40	RAL 7030 Grey	24x2 m.
CWD 8060-G	80x60	RAL 7030 Grey	16x2 m.
CWD 8080-G	80x80	RAL 7030 Grey	12x2 m.
CWD 8010-G	80x100	RAL 7030 Grey	8x2 m.
CWD 1060-G	100x60	RAL 7030 Grey	12x2 m.
CWD 1080-G	100x80	RAL 7030 Grey	10x2 m.
CWD 1010-G	100x100	RAL 7030 Grey	8x2 m.
CWD 1260-G	120x60	RAL 7030 Grey	8x2 m.
CWD 1280-G	120x80	RAL 7030 Grey	8x2 m.
CWD 1210-G	120x100	RAL 7030 Grey	8x2 m.



*Different color options

Wiring Duct Covers

Code	Dimension (mm)	Colour	Pack (piece)
CWC 250	25	RAL 7030 Grey	10x2 m.
CWC 400	40	RAL 7030 Grey	10x2 m.
CWC 600	60	RAL 7030 Grey	10x2 m.
CWC 800	80	RAL 7030 Grey	10x2 m.
CWC 1000	100	RAL 7030 Grey	10x2 m.
CWC 1200	120	RAL 7030 Grey	10x2 m.

CABLE DUCTS

wiring ducts

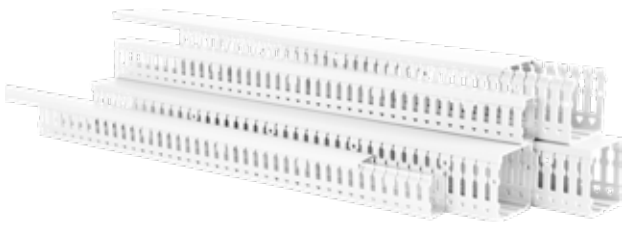

*Different color options

Wiring Ducts (Included Cover) (6 mm)

Code	Dimension (mm)	Colour	Pack (piece)
CWD 2525 W-1	25x25	RAL 9016 White	60x2 m.
CWD 2540 W-1	25x40	RAL 9016 White	50x2 m.
CWD 2560 W-1	25x60	RAL 9016 White	30x2 m.
CWD 2580 W1	25x80	RAL 9016 White	24x2 m.
CWD 2510 W-1	25x100	RAL 9016 White	16x2 m.
CWD 4025 W-1	40x25	RAL 9016 White	40x2 m.
CWD 4040 W-1	40x40	RAL 9016 White	26x2 m.
CWD 4060 W-1	40x60	RAL 9016 White	18x2 m.
CWD 4080 W-1	40x80	RAL 9016 White	24x2 m.
CWD 4010 W-1	40x100	RAL 9016 White	20x2 m.
CWD 6040 W-1	60x40	RAL 9016 White	18x2 m.
CWD 6060 W-1	60x60	RAL 9016 White	24x2 m.
CWD 6080 W-1	60x80	RAL 9016 White	18x2 m.
CWD 6010 W-1	60x100	RAL 9016 White	12x2 m.
CWD 8040 W-1	80x40	RAL 9016 White	24x2 m.
CWD 8060 W-1	80x60	RAL 9016 White	16x2 m.
CWD 8080 W-1	80x80	RAL 9016 White	12x2 m.
CWD 8010 W-1	80x100	RAL 9016 White	8x2 m.
CWD 1060 W-1	100x60	RAL 9016 White	12x2 m.
CWD 1080 W-1	100x80	RAL 9016 White	10x2 m.
CWD 1010 W-1	100x100	RAL 9016 White	8x2 m.
CWD 1260 W-1	120x60	RAL 9016 White	8x2 m.
CWD 1280 W-1	120x80	RAL 9016 White	8x2 m.
CWD 1210 W-1	120x100	RAL 9016 White	8x2 m.

(UL Certificate) an independent product safety certification institution, is a certificate issued to products that have passed safety tests and procedures, including many parameters.

Wiring Ducts

Code	Dimension (mm)	Colour	Pack (piece)
NS-CWD 2525G	25x25	RAL 7030 Grey	60x2 m.
NS-CWD 2540G	25x40	RAL 7030 Grey	50x2 m.
NS-CWD 2560G	25x60	RAL 7030 Grey	30x2 m.
NS-CWD 2580G	25x80	RAL 7030 Grey	24x2 m.
NS-CWD 2510G	25x100	RAL 7030 Grey	16x2 m.
NS-CWD 4025G	40x25	RAL 7030 Grey	40x2 m.
NS-CWD 4040G	40x40	RAL 7030 Grey	26x2 m.
NS-CWD 4060G	40x60	RAL 7030 Grey	18x2 m.
NS-CWD 4080G	40x80	RAL 7030 Grey	24x2 m.
NS-CWD 4010G	40x100	RAL 7030 Grey	20x2 m.
NS-CWD 6040G	60x40	RAL 7030 Grey	18x2 m.
NS-CWD 6060G	60x60	RAL 7030 Grey	24x2 m.
NS-CWD 6080G	60x80	RAL 7030 Grey	18x2 m.
NS-CWD 6010G	60x100	RAL 7030 Grey	12x2 m.
NS-CWD 8040G	80x40	RAL 7030 Grey	24x2 m.
NS-CWD 8060G	80x60	RAL 7030 Grey	16x2 m.
NS-CWD 8080G	80x80	RAL 7030 Grey	12x2 m.
NS-CWD 8010G	80x100	RAL 7030 Grey	8x2 m.
NS-CWD 1060G	100x60	RAL 7030 Grey	12x2 m.
NS-CWD 1080G	100x80	RAL 7030 Grey	10x2 m.
NS-CWD 1010G	100x100	RAL 7030 Grey	8x2 m.
NS-CWD 1260G	120x60	RAL 7030 Grey	8x2 m.
NS-CWD 1280G	120x80	RAL 7030 Grey	8x2 m.
NS-CWD 1210G	120x100	RAL 7030 Grey	8x2 m.



Technical Characteristic

- Flexible spiral
- Made of polyvinyl chloride (P-PVC)
- Reinforced with a spiral made of polyvinyl chloride (U-PVC)
- Choices for different colours
- Suitable for light mechanical loads
- Self extinguishing, flame retardant
- Conform to European IEC standards EN 606170-1



Flexible Spiralled Sheath - Grey

Code	Dimension (Ø)	Pack
CP 30010	Ø 10 mm.	30
CP 30012	Ø 12 mm.	30
CP 30014	Ø 14 mm.	30
CP 30016	Ø 16 mm.	30
CP 30020	Ø 20 mm.	30
CP 30022	Ø 22 mm.	30
CP 30025	Ø 25 mm.	30
CP 30030	Ø 30 mm.	30
CP 30032	Ø 32 mm.	30
CP 30038	Ø 38 mm.	30



Flexible Spiralled Sheath - Black

Code	Dimension (Ø)	Pack
CP 31010	Ø 10 mm.	30
CP 31012	Ø 12 mm.	30
CP 31014	Ø 14 mm.	30
CP 31016	Ø 16 mm.	30
CP 31020	Ø 20 mm.	30
CP 31022	Ø 22 mm.	30
CP 31025	Ø 25 mm.	30
CP 31030	Ø 30 mm.	30
CP 31032	Ø 32 mm.	30
CP 31038	Ø 38 mm.	30

Flexible Spiralled Sheath Glands



Code	Description	Pack
DX 54408	Ø 8 PG7	20
DX 54410	Ø 10 PG7	20
DX 54411	Ø 10 PG9	20
DX 54412	Ø 12 PG11	10
DX 54413	Ø 12 PG13,5	10
DX 54414	Ø 14 PG13,5	10
DX 54416	Ø 16 PG13,5	10
DX 54417	Ø 16 PG16	10
DX 54420	Ø 20 PG21	10
DX 54422	Ø 22 PG21	10
DX 54425	Ø 25 PG29	5
DX 54428	Ø 28 PG29	5
DX 54432	Ø 32 PG36	5
DX 54435	Ø 35 PG36	5



www.cetinkayapano.com



METAL CABINETS

D series

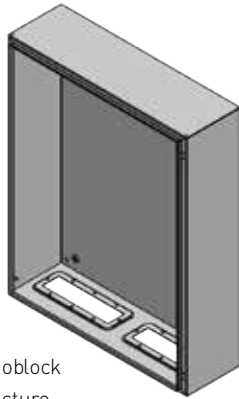

Monoblock Structure

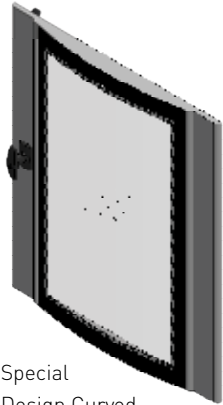

Special Design Curved Glass Door



Pure Material for high quality sealing

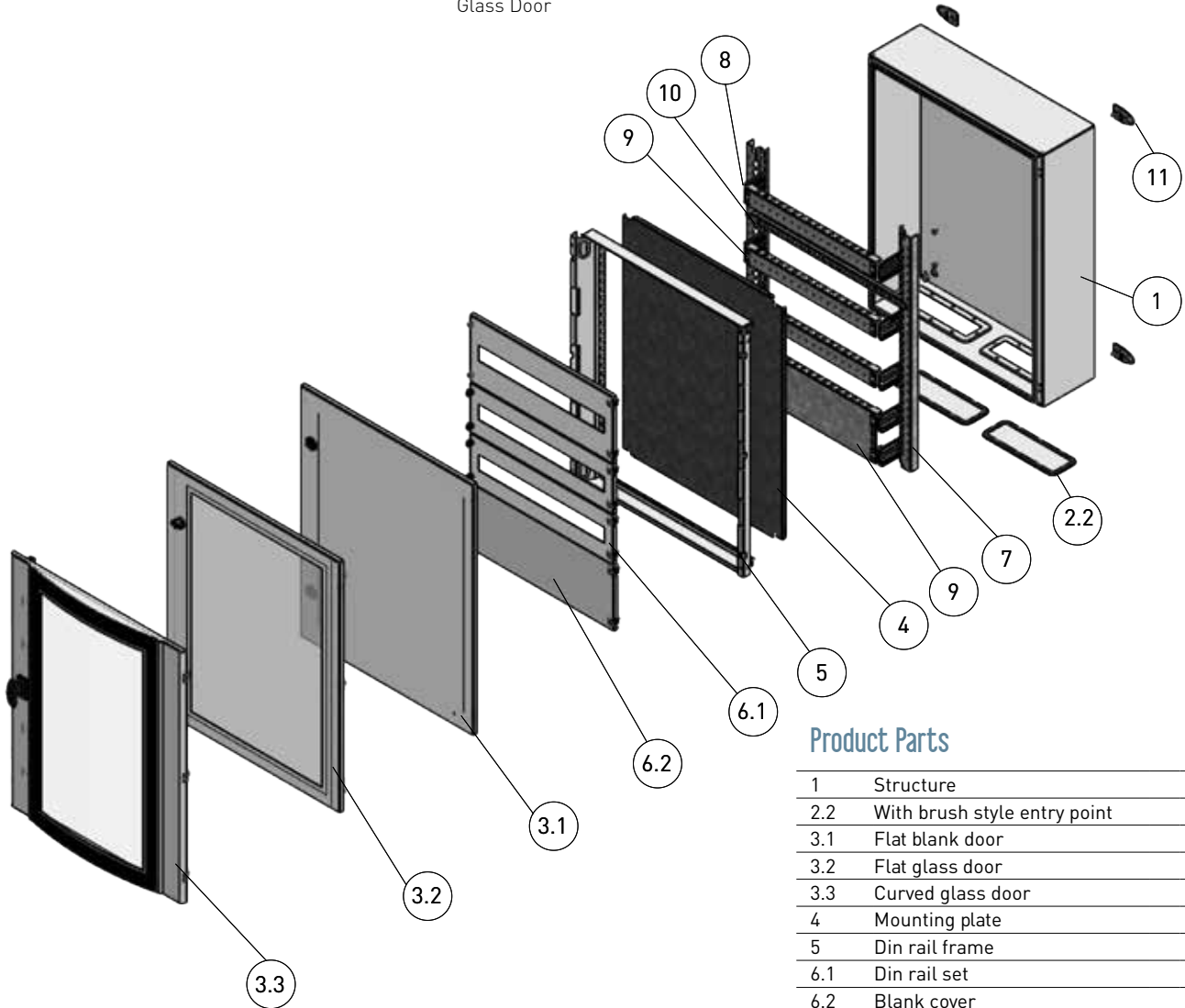

Product Parts

1	Structure
2.2	With brush style entry point
3.1	Flat blank door
3.2	Flat glass door
3.3	Curved glass door
4	Mounting plate
5	Din rail frame
6.1	Din rail set
6.2	Blank cover
7	Vertical modular part
8	Accessory for the depth adjustment
9	Blank plate
10	Cable ducts fixing accessory
11	Wall mounting accessory

Floor Mounting & Surface Mounting Cabinets

DISTRIBUTION BOARDS with PLAIN DOOR

floor mounting & surface mounting



Technical Characteristic

- From 48 to 264 Modules
- Easy and Fast Installation
- Wide Space for the Cabling
- Pre-Drilled Entries For an Easy Installation
- Plain Door
- Triangle Lock System



CPD Surface Distribution Cabinets with Din Rail Accessory + Blank cover h:150 mm

Code	Dimension (WxHxD)	DIN Rail Modules	Pack
CPD 6006020 SUMPB	600x600x200	48M (24x2 rows) + Blank Cover	1
CPD 6007520 SUMPB	600x750x200	72M (24x3 rows) + Blank Cover	1
CPD 6009020 SUMPB	600x900x200	96M (24x4 rows) + Blank Cover	1
CPD 6010520 SUMPB	600x1050x200	120M (24x5 rows) + Blank Cover	1
CPD 6012025 SUMPB	600x1200x250	144M (24x6 rows) + Blank Cover	1
CPD 6015025 SUMPB	600x1500x250	192M (24x8 rows) + Blank Cover	1
CPD 6018025 SUMPB	600x1800x250	240M (24x10 rows) + Blank Cover	1

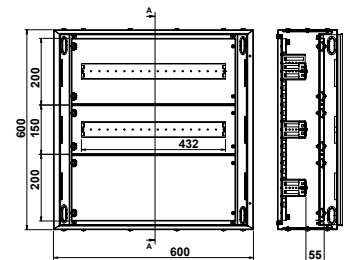

CPD Surface Distribution Cabinets with Din Rail Accessory

Code	Dimension (WxHxD)	DIN Rail Modules	Pack
CPD 6006020 SUMSB	600x600x200	72M (24x3 rows)	1
CPD 6007520 SUMSB	600x750x200	96M (24x4 rows)	1
CPD 6009020 SUMSB	600x900x200	120M (24x5 rows)	1
CPD 6010520 SUMSB	600x1050x200	144M (24x6 rows)	1
CPD 6012025 SUMSB	600x1200x250	168M (24x7 rows)	1
CPD 6015025 SUMSB	600x1500x250	216M (24x9 rows)	1
CPD 6018025 SUMSB	600x1800x250	264M (24x11 rows)	1

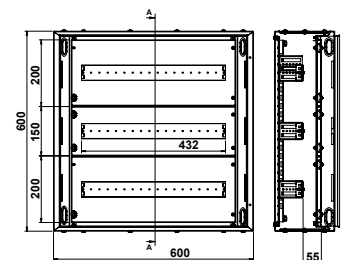

CURVED SAFETY GLASS DOOR CABINETS

floor mounting & surface mounting



Technical Characteristic

- From 48 to 264 Modules
- Easy and Fast Installation
- Wide Space for the Cabling
- Pre-Drilled Entries For an Easy Installation
- Tempered Glass Door
- Triangle Lock System



CPD Surface Distribution Cabinets with Din Rail Accessory + Blank cover h:150 mm

Code	Dimension (WxHxD)	DIN Rail Modules	Pack
CPD 6006020 SUMP	600x600x200	48M (24x2 rows) + Blank Cover	1
CPD 6007520 SUMP	600x750x200	72M (24x3 rows) + Blank Cover	1
CPD 6009020 SUMP	600x900x200	96M (24x4 rows) + Blank Cover	1
CPD 6010520 SUMP	600x1050x200	120M (24x5 rows) + Blank Cover	1
CPD 6012025 SUMP	600x1200x250	144M (24x6 rows) + Blank Cover	1
CPD 6015025 SUMP	600x1500x250	192M (24x8 rows) + Blank Cover	1
CPD 6018025 SUMP	600x1800x250	240M (24x10 rows) + Blank Cover	1

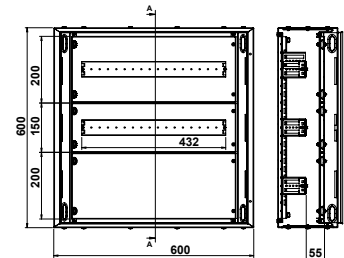

CPD Surface Distribution Cabinets with Din Rail Accessory

Code	Dimension (WxHxD)	DIN Rail Modules	Pack
CPD 6006020 SUMS	600x600x200	72M (24x3 rows)	1
CPD 6007520 SUMS	600x750x200	96M (24x4 rows)	1
CPD 6009020 SUMS	600x900x200	120M (24x5 rows)	1
CPD 6010520 SUMS	600x1050x200	144M (24x6 rows)	1
CPD 6012025 SUMS	600x1200x250	168M (24x7 rows)	1
CPD 6015025 SUMS	600x1500x250	216M (24x9 rows)	1
CPD 6018025 SUMS	600x1800x250	264M (24x11 rows)	1

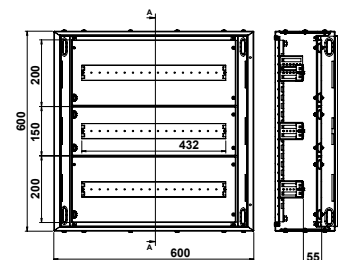

CURVED SAFETY GLASS DOOR CABINETS

floor mounting & surface mounting



Technical Characteristic

- Usage for installation of electrical instruments
- Easy and Fast Installation
- Wide Space for the Cabling
- Pre-Drilled Entries For an Easy Installation
- Tempered Glass Door
- Thickness is 1.20 mm
- Triangle Lock System

CPD Surface Distribution Cabinets with Mounting Plate

Code	Dimension (WxHxD)	DIN Rail Modules	Pack
CPD 6006020 SUM	600x600x200	Mounting Plate	1
CPD 6007520 SUM	600x750x200	Mounting Plate	1
CPD 6009020 SUM	600x900x200	Mounting Plate	1
CPD 6010520 SUM	600x1050x200	Mounting Plate	1
CPD 6012025 SUM	600x1200x250	Mounting Plate	1
CPD 6015025 SUM	600x1500x250	Mounting Plate	1
CPD 6018025 SUM	600x1800x250	Mounting Plate	1



Complementary Items

Code	Din Modules	Pack
CP 12011	Terminal Blocks - 24M	1
CP 12012	Terminal Blocks - 36M	1
CPD 606024	24M Din Rail Kit - 150mm.Height	1
CPD 606025	24M Din Rail Kit - 200mm.Height	1
CPD 606034	Blank Module Cover - 150mm.Height	1
CPD 606035	Blank Module Cover - 200mm.Height	1
CPD 606034M	Mounting Plate for CP606034	1
CPD 606035M	Mounting Plate for CP606035	1
CPD 606044	Base Plate for Floor Installation - 20 cm	1
CPD 606054	Base Plate for Floor Installation - 25cm	1
CPD 606045	Metal Lock Set For CPD range	1



CP 12012



CPD606024



CPD606034



CPD606034M



CPD606044



CPD606045

CURVED SAFETY GLASS DOOR CABINETS

▶ floor mounting & surface mounting



Technical Characteristic

- Usage for installation of electrical instruments
- Easy and Fast Installation
- Wide Space for the Cabling
- Pre-Drilled Entries For an Easy Installation
- Tempered Glass Door
- Thickness is 1.20 mm



CPD - Surface Mounting Distribution Cabinets - with mounting plate

Code	Dimension (WxHxD)	DIN Rail Modules	Pack
CPD 4005015 SUM	400x500x150	Mounting Plate	1
CPD 4006515 SUM	400x650x150	Mounting Plate	1
CPD 4505015 SUM	450x500x150	Mounting Plate	1
CPD 4506515 SUM	450x650x150	Mounting Plate	1



CPD Surface Mounting Distribution Cabinets with Din rail Accessory + Blank Cover H : 150mm

Code	Dimension (WxHxD)	DIN Rail Modules	Pack
CPD 4005015 SUPP	400x500x150	30M (15x2 rows)	1
CPD 4006515 SUPP	400x650x150	45M (15x3 rows)	1
CPD 4505015 SUPP	450x500x150	34M (17x2 rows)	1
CPD 4506515 SUPP	450x650x150	51M (17x3 rows)	1



CPD Surface Distribution Cabinets - with Din Rail Accessory

Code	Dimension (WxHxD)	DIN Rail Modules	Pack
CPD 4005015 SUPS	400x500x150	45M (15 x 3 rows)	1
CPD 4006515 SUPS	400x650x150	60M (15 x 4 rows)	1
CPD 4505015 SUPS	450x500x150	51M (17 x 3 rows)	1
CPD 4506515 SUPS	450x650x150	68M (17 x 4 rows)	1

CURVED SAFETY GLASS DOOR CABINETS

flush mounting



Technical Characteristic

- Usage for installation of electrical instruments
- Easy and Fast Installation
- Wide Space for the Cabling
- Pre-Drilled Entries For an Easy Installation
- Tempered Glass Door
- Thickness is 1.20 mm
- Triangle Lock System



CPD Flush Mounting Distribution Cabinets with Mounting Plate

Code	Dimension (WxHxD)	DIN Rail Modules	Pack
CPD 6006010 SAM	600x600x100	Mounting Plate	1
CPD 6007510 SAM	600x750x100	Mounting Plate	1
CPD 6009010 SAM	600x900x100	Mounting Plate	1
CPD 6010510 SAM	600x1050x100	Mounting Plate	1



CPD Flush Mounting Distribution Cabinets with Din Rail Accessory + Blank Cover H : 200mm

Code	Dimension (WxHxD)	DIN Rail Modules	Pack
CPD 6006010 SAPP	600x600x100	66M (22x3 rows)	1
CPD 6007510 SAPP	600x750x100	88M (22x4 rows)	1
CPD 6009010 SAPP	600x900x100	110M (22x5 rows)	1
CPD 6010510 SAPP	600x1050x100	132M (22 x 6 rows)	1



CPD - Flush Mounting Distribution Cabinets - with Din Rail Accessory

Code	Dimension (WxHxD)	DIN Rail Modules	Pack
CPD 6006010 SAPS	600x600x100	88M (22x4 rows)	1
CPD 6007510 SAPS	600x750x100	110M (22x5 rows)	1
CPD 6009010 SAPS	600x900x100	132M (22x6 rows)	1
CPD 6010510 SAPS	600x1050x100	154M (22x7 rows)	1

CURVED SAFETY GLASS DOOR CABINETS

flush mounting



Technical Characteristic

- Usage for installation of electrical instruments
- Easy and Fast Installation
- Wide Space for the Cabling
- Pre-Drilled Entries For an Easy Installation
- Tempered Glass Door
- Thickness is 1.20 mm
- Triangle Lock System



CPD - Flush Mounting -Distribution Cabinets - with mounting plate

Code	Dimension (WxHxD)	DIN Rail Modules	Pack
CPD 4005010 SAM	400x500x100	Mounting Plate	1
CPD 4006510 SAM	400x650x100	Mounting Plate	1
CPD 4505010 SAM	450x500x100	Mounting Plate	1
CPD 4506510 SAM	450x650x100	Mounting Plate	1



CPD - Flush Mounting Distribution Cabinets with Din rail accessory + Blank Cover

Code	Dimension (WxHxD)	DIN Rail Modules	Pack
CPD 4005010 SAPP	400x500x100	30m (15x2 rows)	1
CPD 4006510 SAPP	400x650x100	45M (15x3 rows)	1
CPD 4505010 SAPP	450x500x100	34M (17x2 rows)	1
CPD 4506510 SAPP	450x650x100	51M (17x3 rows)	1



CPD Flush Mounting Distribution Cabinets with Din Rail Accessory

Code	Dimension (WxHxD)	DIN Rail Modules	Pack
CPD 4005010 SAPS	400x500x100	30M (15x3 rows)	1
CPD 4006510 SAPS	400x650x100	45M (15x4 rows)	1
CPD 4505010 SAPS	450x500x100	34M (17x3 rows)	1
CPD 4506510 SAPS	450x650x100	51M (17x4 rows)	1

ENCLOSURE FOR COMMUNICATION DEVICES

Technical Characteristic

- Thickness 1 mm
- Cable entry place are invisible
- Telephone connection
- Modems are routers
- Antenna, cable or satellite T.V. connection
- Included mounting plate
- Fitted with PC smoked window
- Polycarbonate window
- RAL 7035



FLUSH MOUNTING - Enclosure with MCB modules & place for network cabling

Code	Dimension (WxHxD)	DIN Rail Modules	Pack
CP 8500	400x700x100	24M (12x2)	1
CP 8501	500x850x120	36M (12x3)	1



SURFACE MOUNTING - Enclosure with MCB modules & place for network cabling

Code	Dimension (WxHxD)	DIN Rail Modules	Pack
CP 8510	400x700x100	24M (12x2)	1
CP 8511	500x850x120	36M (12x3)	1



FLUSH MOUNTING - Enclosure with MCB modules & place for network cabling

Code	Dimension (WxHxD)	DIN Rail Modules	Pack
new CP 8502	592x350x95	24M (12x2)	1
new CP 8503	592x490x95	36M (12x3)	1

ENCLOSURE FOR COMMUNICATION DEVICES

Technical Characteristic

- Thickness 1 mm
- Cable entry place are invisible
- Telephone connection
- Modems are routers
- Antenna, cable or satellite T.V. connection
- Included mounting plate
- Fitted with PC smoked window
- Polycarbonate window
- RAL 7035



FLUSH MOUNTING - Enclosure with MCB modules & place for network cabling / plastic frame

Code	Dimension (WxHxD)	DIN Rail Modules	Pack
new CP 8520	603x314x95	24M (12x2)	1
new CP 8521	603x454x95	36M (12x3)	1



FLUSH MOUNTING - Enclosure with MCB modules & place for network cabling / plastic frame

Code	Dimension (WxHxD)	DIN Rail Modules	Pack
new CP 8522	603x314x95	24M (12x2)	1
new CP 8523	603x454x95	36M (12x3)	1



SLIM LINE RACK CABINET

Code	Dimension (WxHxD)		Pack
CR 711	497x140x475	3U+2U	1

METAL ENCLOSURES

▶ wall mounted



Technical Characteristic

- Color, RAL 7035 Grey
- Thickness 0,80 mm
- IP 54
- Included Galvanized Mounting Plate
- For Indoor Use
- Bottom Flash (Gland) Plate
- Hidden Hinges
- Foamed In door Gasket

Metal Enclosure

Code	Dimension (WxHxD)	Pack
CP 202515 K	200x250x150	1
CP 203015 K	200x300x150	1
CP 253015 K	250x300x150	1
CP 303015 K	300x300x150	1
CP 303020 K	300x300x200	1
CP 303515 K	300x350x150	1
CP 303520 K	300x350x200	1
CP 304015 K	300x400x150	1
CP 304020 K	300x400x200	1
CP 304025 K	300x400x250	1
CP 354515 K	350x450x150	1
CP 354520 K	350x450x200	1
CP 354525 K	350x450x250	1
CP 405020 K	400x500x200	1
CP 405025 K	400x500x250	1
CP 406020 K	400x600x200	1
CP 406025 K	400x600x250	1
CP 406030 K	400x600x300	1
CP 506020 K	500x600x200	1
CP 506025 K	500x600x250	1
CP 506030 K	500x600x300	1
CP 507020 K	500x700x200	1
CP 507025 K	500x700x250	1
CP 507030 K	500x700x300	1
CP 607020 K	600x700x200	1
CP 607025 K	600x700x250	1
CP 607030 K	600x700x300	1
CP 608020 K	600x800x200	1
CP 608025 K	600x800x250	1
CP 608030 K	600x800x300	1
CP 609020 K	600x900x200	1
CP 609025 K	600x900x250	1
CP 609030 K	600x900x300	1
CP 6010020 K	600x1000x200	1
CP 6010025 K	600x1000x250	1
CP 6010030 K	600x1000x300	1

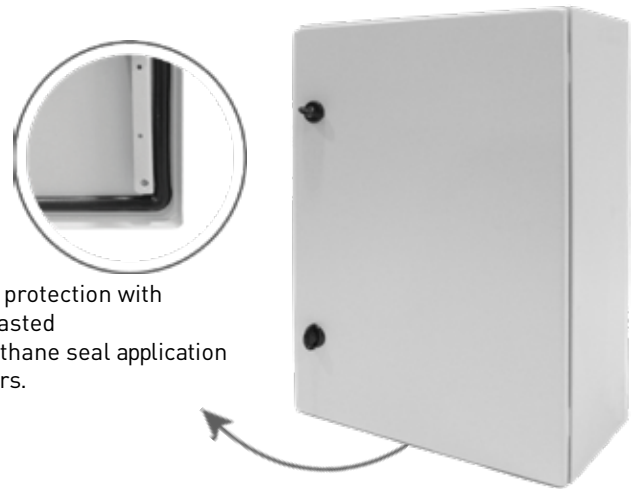

High IP protection with liquid casted polyurethane seal application on covers.

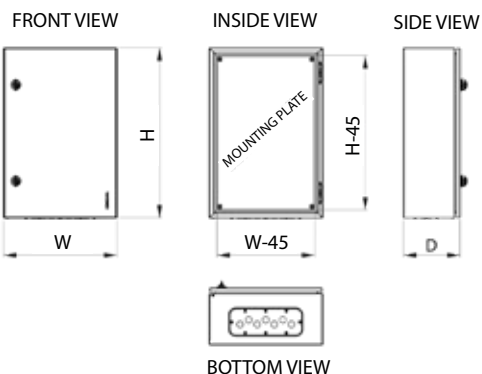
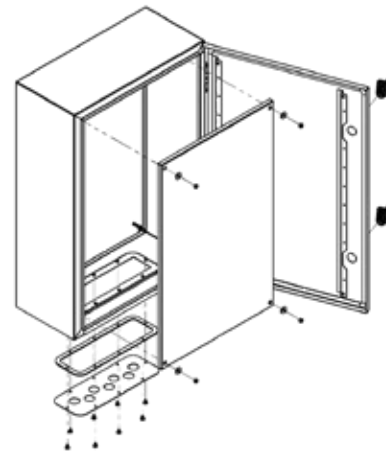

METAL ENCLOSURES

▶ wall mounted



Technical Characteristic

- Color, RAL 7035 Grey
- Thickness 1,20 mm up to 1,50 mm
- IP 66
- Included Galvanized Mounting Plate
- Foamed in Door Gasket
- Bottom Flash (Gland) Plate
- Hidden Hinges



High IP protection with liquid casted polyurethane seal application on covers.

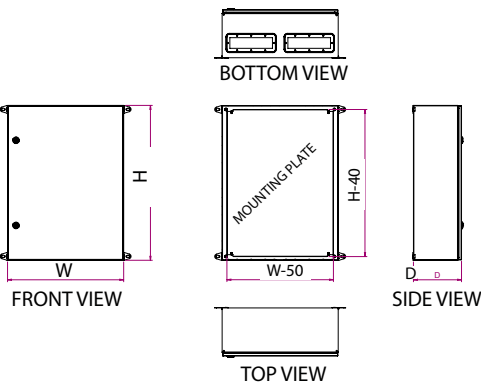
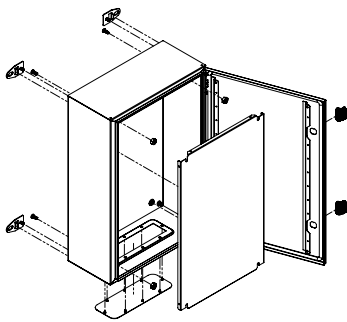

Metal Enclosure

Code	Dimension (WxHxD)	Pack
CP 202515 E	200x250x150	1
CP 203015 E	200x300x150	1
CP 253015 E	250x300x150	1
CP 303015 E	300x300x150	1
CP 303020 E	300x300x200	1
CP 303515 E	300x350x150	1
CP 303520 E	300x350x200	1
CP 304015 E	300x400x150	1
CP 304020 E	300x400x200	1
CP 304025 E	300x400x250	1
CP 354520 E	350x450x200	1
CP 354525 E	350x450x250	1
CP 404020 E	400x400x200	1
CP 405020 E	400x500x200	1
CP 405025 E	400x500x250	1
CP 406020 E	400x600x200	1
CP 406025 E	400x600x250	1
CP 406030 E	400x600x300	1
new CP 505020 E	500x500x200	1
CP 506020 E	500x600x200	1
CP 506025 E	500x600x250	1
CP 506030 E	500x600x300	1
CP 507020 E	500x700x200	1
CP 507025 E	500x700x250	1
CP 507030 E	500x700x300	1
new CP 606020 E	600x600x200	1
CP 607020 E	600x700x200	1
CP 607025 E	600x700x250	1
CP 608020 E	600x800x200	1
CP 608025 E	600x800x250	1
CP 608030 E	600x800x300	1
CP 609025 E	600x900x250	1
CP 609030 E	600x900x300	1
CP 6010020 E	600x1000x200	1
CP 6010025 E	600x1000x250	1
CP 6010030 E	600x1000x300	1
CP 6010040 E	600x1000x400	1
CP 6012020 E	600x1200x200	1
CP 6012030 E	600x1200x300	1
CP 6014030 E	600x1400x300	1
CP 6014040 E	600x1400x400	1
CP 7010020 E	700x1000x200	1
CP 7010025 E	700x1000x250	1
CP 7010030 E	700x1000x300	1
CP 7010040 E	700x1000x400	1
CP 7012020 E	700x1200x200	1
CP 7012030 E	700x1200x300	1
CP 7012040 E	700x1200x400	1
CP 7014030 E	700x1400x300	1
CP 7014040 E	700x1400x400	1
CP 8010020 E	800x1000x200	1
CP 8010025 E	800x1000x250	1
CP 8010030 E	800x1000x300	1
CP 8010040 E	800x1000x400	1
CP 8012025 E	800x1200x250	1
CP 8012030 E	800x1200x300	1
CP 8014030 E	800x1400x300	1
CP 8014040 E	800x1400x400	1

Metal Enclosure Roof

Code	Dimension (WxHxD)	A	B	Pack
CP 3020 C	300X200	300	200	1
CP 4020 C	400X200	400		1
CP 5020 C	500X200	500		1
CP 6020 C	600X200	600	250	1
CP 5025 C	500X250	500		1
CP 6025 C	600X250	600		1
CP 8025 C	800X250	800	1	

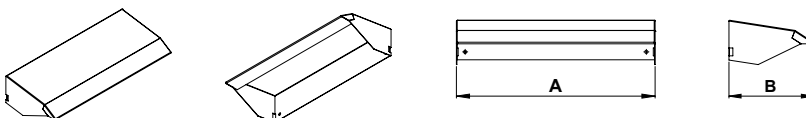
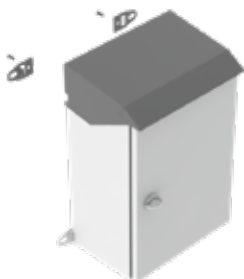

METAL ENCLOSURES

▶ wall mounted



Technical Characteristic

- Color, RAL 7035 Grey
- Thickness 0,80 mm
- IP 54
- Included Galvanized Mounting Plate
- For Indoor Use
- IK10
- Hidden Hinges
- Bottom Flash (Gland) Plate

Metal Enclosures

Code	Dimension (WxHxD)	Pack
CP 302015 Y	300x200x150	1
CP 302515 Y	300x250x150	1
CP 252015 Y	250x200x150	1
CP 352515 Y	350x250x150	1
CP 352520 Y	350x250x200	1
CP 353015 Y	350x300x150	1
CP 353020 Y	350x300x200	1
CP 403015 Y	400x300x150	1
CP 403020 Y	400x300x200	1
CP 403025 Y	400x300x250	1
CP 453515 Y	450x350x150	1
CP 453520 Y	450x350x200	1
CP 453525 Y	450x350x250	1
CP 504020 Y	500x400x200	1
CP 504025 Y	500x400x250	1
CP 604020 Y	600x400x200	1
CP 604025 Y	600x400x250	1
CP 605020 Y	600x500x200	1
CP 605025 Y	600x500x250	1
CP 605030 Y	600x500x300	1

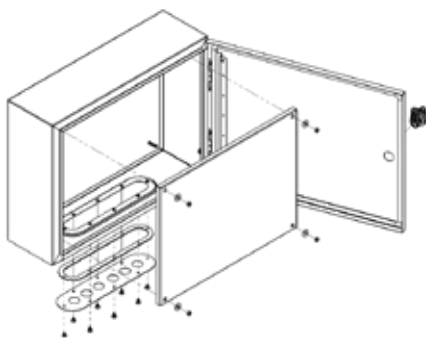
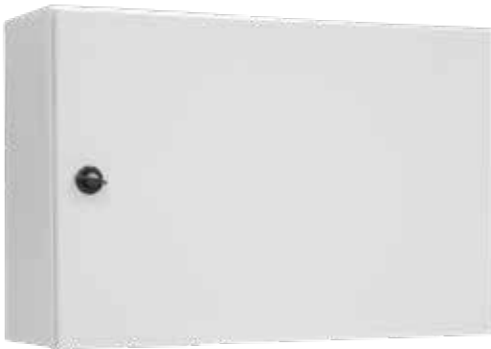

FRONT VIEW

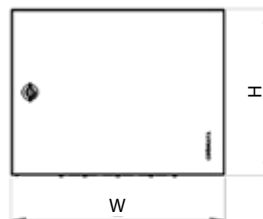

INSIDE VIEW

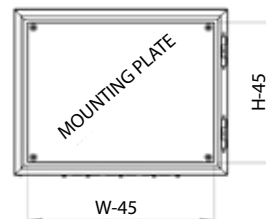

SIDE VIEW



BOTTOM VIEW

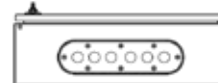

Wall Mounted-glass door

Code	Dimension (WxHxD)	Pack
CP 140	300 x 400 x 200	1
CP 141	400 x 500 x 200	1
CP 142	400 x 600 x 200	1
CP 143	500 x 700 x 200	1
CP 144	600 x 800 x 200	1
CP 145	600 x 1000 x 250	1

METAL ENCLOSURES

▶ wall mounted & floor installation



Technical Characteristic

- Color, RAL 7035 Grey
- IP65 Protection
- Sheet Steel 1,20 mm
- Foamed in Door Gasket
- Mounting Plate in Galvanized
- Bottom Flansh(Gland) Plate
- Hidden Hinges

Wall Mounted

Code	Dimension (WxHxD)	Pack
CP 130	300 x 400 x 200	1
CP 131	400 x 500 x 200	1
CP 132	400 x 600 x 200	1
CP 133	500 x 700 x 200	1
CP 134	600 x 800 x 200	1
CP 135	600 x 1000 x 250	1

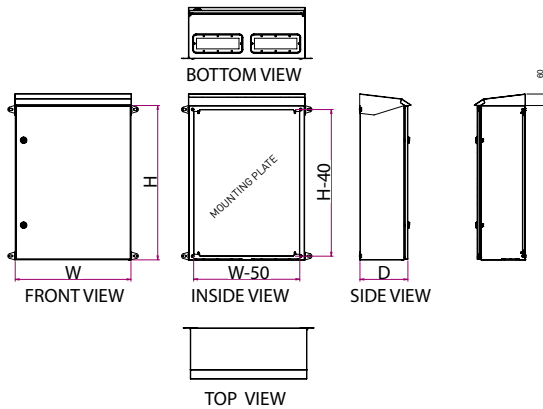

For Floor Installation

Code	Dimension (WxHxD)	Pack
CP 150	400 x 660 x 200	1
CP 151	400 x 860 x 250	1
CP 152	500 x 660 x 250	1
CP 153	500 x 860 x 250	1
CP 155	600 x 860 x 300	1
CP 156	600 x 1060 x 300	1
CP 157	600 x 1260 x 300	1
CP 161	700 x 1060 x 300	1
CP 162	700 x 1260 x 400	1
CP 167	800 x 1260 x 400	1

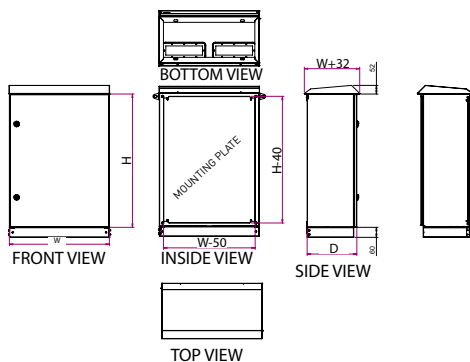

METAL ENCLOSURES

▶ surface & flush mounting

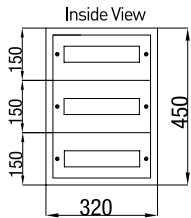

CPR 801



Surface Mounted

Code	Dimension (WxHxD)	Description	Pack
CPR 800	320x300x150	24M (2x12)	1
CPR 801	320x450x150	36M (3x12)	1
CPR 802	320x600x175	48M (4x12)	1
CPR 803	400x600x175	60M (4x15)	1

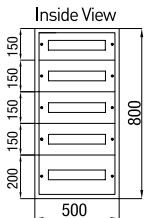

CPR 804



Surface Mounted

Code	Dimension (WxHxD)	Description	Pack
CPR 804	500x800x175	100M (5x20)	1
CPR 805	500x950x175	120M (6x20)	1
CPR 806	750x800x200	150M (10x15) Double Doors	1
CPR 807	750x1000x200	180M (12x15) Double Doors	1

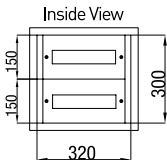

CPR 820



Flush Mounted

Code	Dimension (WxHxD)	Description	Pack
CPR 820	320x300x140	24M (2x12)	1
CPR 821	320x450x140	36M (3x12)	1
CPR 822	320x600x140	48M (4x12)	1
CPR 823	400x600x140	60M (4x15)	1

Flush Mounted

Code	Dimension (WxHxD)	Description	Pack
CPR 824	500x800x140	100M (5x20)	1
CPR 825	500x950x165	120M (6x20)	1
CPR 826	750x800x165	150M (10x15) Double Doors	1
CPR 827	750x1000x165	180M (12x15) Double Doors	1

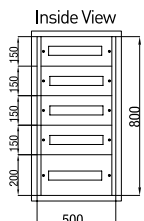

CPR 824



Complementary Items

Code	Dimension (WxHxD)	Description	Pack
CPR 8012 B	145x273	12M Blank Cover	1
CPR 8015 B	145x352	15M Blank Cover	1
CPR 8012 D	145x273	12M DIN Rail Frame	1
CPR 8015 D	145x352	15M DIN Rail Frame	1
CPR 8020 D	145x453	Open Cover Plate + Din Rail Set	1
CPR 8020 B	145x453	Blank Cover Plate	1
CPR 8020-1B	194x453	Blank Cover Plate	1
CPR 8020-1D	194x453	Open Cover Plate + Din Rail Set	1
CPR 8016 B	145x323	Blank Cover Plate	1
CPR 8016 D	145x323	Open Cover Plate + Din Rail Set	1
CPR 8016-1B	194x323	Blank Cover Plate	1
CPR 8016-1D	194x323	Open Cover Plate + Din Rail Set	1

A SERIES VERTICAL TYPE MODULER BOARD



You  Tube



You can access our montage video by reading the QR code from your phone's camera or the QR code reading applications.

A SERIES VERTICAL TYPE MODULER BOARD

floor standing moduler enclosure



Technical Characteristic

- Color, RAL 7035 Grey
- Modular System for Indoor Application
- Frame&Door: 1,50 mm
- Removable Side and Back Panels
- Depth Adjustable Mounting Plate
- Foamed in Door Gasket
- Base Plate for Floor Installation
- IK 10
- IP55
- IP41
- Disassembled Shipment
- Seismic Test Certification



FRONT VIEW

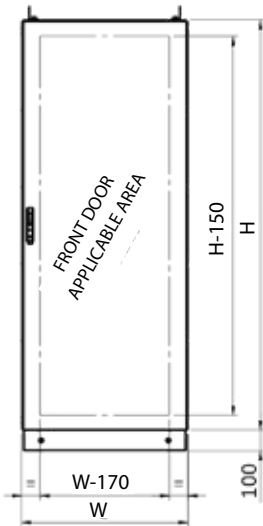

INSIDE VIEW

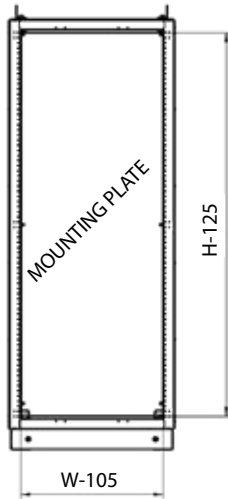

SIDE VIEW

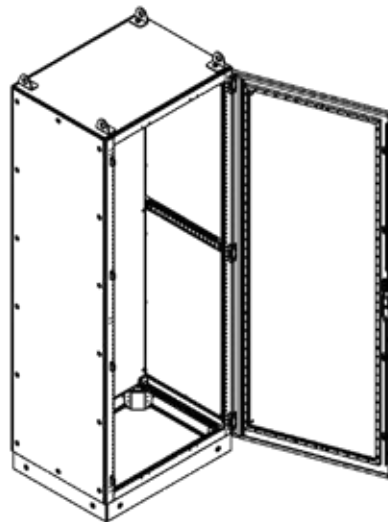
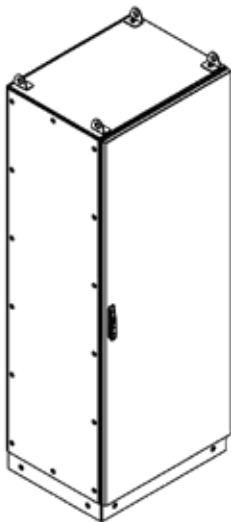
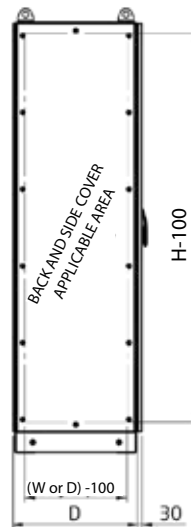

A Series Vertical Type Moduler Board

Code	Dimension (WxHxD)	Pack
CPA 5018040 MPT	500x1800x400	1
CPA 5018050 MPT	500x1800x500	1
CPA 5018060 MPT	500x1800x600	1
CPA 5020040 MPT	500x2000x400	1
CPA 5020050 MPT	500x2000x500	1
CPA 5020060 MPT	500x2000x600	1
CPA 6018040 MPT	600x1800x400	1
CPA 6018050 MPT	600x1800x500	1
CPA 6018060 MPT	600x1800x600	1
CPA 6020040 MPT	600x2000x400	1
CPA 6020050 MPT	600x2000x500	1
CPA 6020060 MPT	600x2000x600	1
CPA 7018040 MPT	700x1800x400	1
CPA 7018050 MPT	700x1800x500	1
CPA 7018060 MPT	700x1800x600	1
CPA 7020040 MPT	700x2000x400	1
CPA 7020050 MPT	700x2000x500	1
CPA 7020060 MPT	700x2000x600	1
CPA 8018040 MPT	800x1800x400	1
CPA 8018050 MPT	800x1800x500	1
CPA 8018060 MPT	800x1800x600	1
CPA 8020040 MPT	800x2000x400	1
CPA 8020050 MPT	800x2000x500	1
CPA 8020060 MPT	800x2000x600	1
CPA 9018040 MPT	900x1800x400	1
CPA 9018050 MPT	900x1800x500	1
CPA 9018060 MPT	900x1800x600	1
CPA 9020040 MPT	900x2000x400	1
CPA 9020050 MPT	900x2000x500	1
CPA 9020060 MPT	900x2000x600	1

TOP VIEW

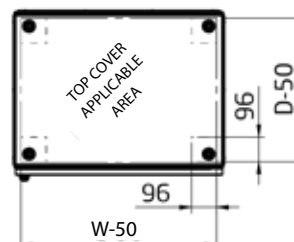

BOTTOM VIEW

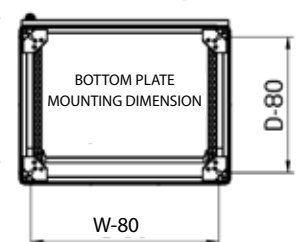

A SERIES VERTICAL TYPE MODULER BOARD

floor standing moduler enclosure



Technical Characteristic

- Color, RAL 7035 Grey
- Modular System for Indoor Application
- Frame&Door: 1,50 mm
- Removable Side and Back Panels
- Depth Adjustable Mounting Plate
- Foamed in Door Gasket
- Base Plate for Floor Installation
- IK 10
- IP55
- IP41
- Disassembled Shipment
- Seismic Test Certification



A Series Vertical Type Moduler Board (Overlapping Door)

Code	Dimension (WxHxD)	Pack
CPA 10018040 MPT	1000x1800x400	1
CPA 10018050 MPT	1000x1800x500	1
CPA 10018060 MPT	1000x1800x600	1
CPA 10020040 MPT	1000x2000x400	1
CPA 10020050 MPT	1000x2000x500	1
CPA 10020060 MPT	1000x2000x600	1

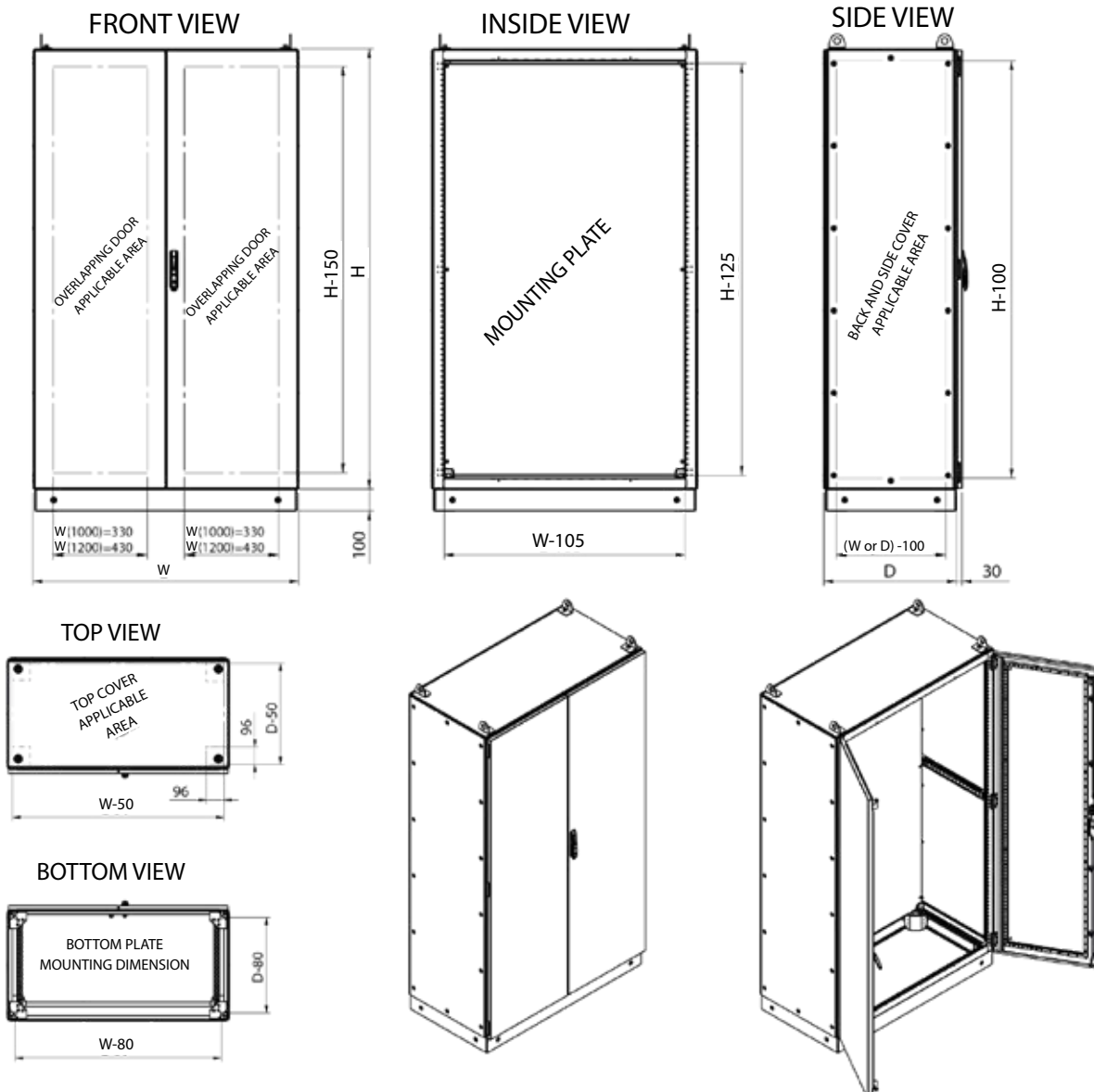

CONTROL PANELS

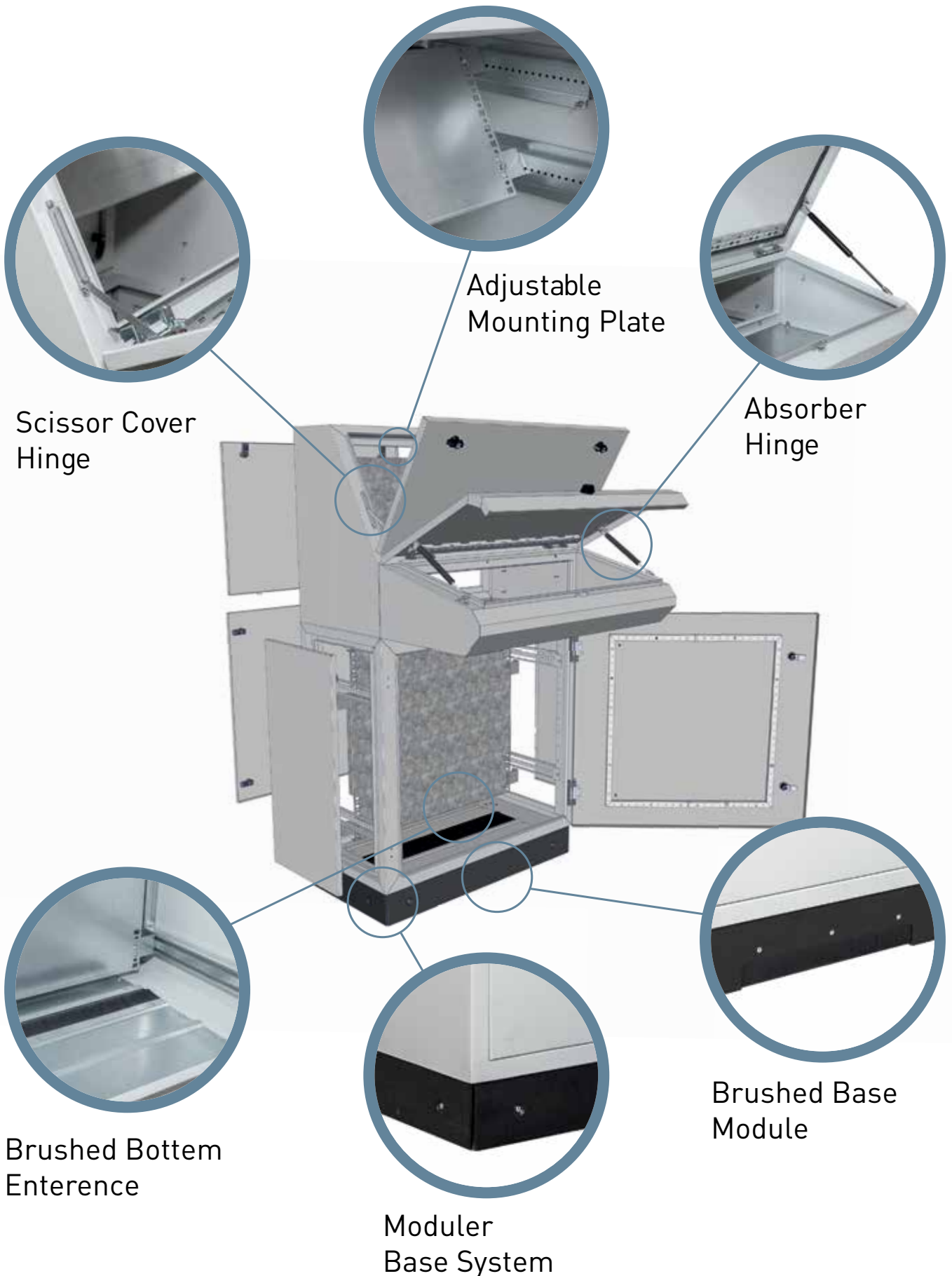

CONTROL PANELS

Technical Characteristic



- Colour Ral7035 Grey
- IK10
- IP40
- Modular body structure
- Mounting System that can be adjusted in depth and Height
- Enclosure has bottom cover and base system
- Shock absorber with upper door , provides easily during service and installation
- Removable back and side door feature easy provides mounting plate.



Control Desk Enclosure Monoblock System

Code	Dimension		
	W	H	D
KMMN0404	400	1075	400
KMMN0604	600	1075	400
KMMN0804	800	1075	400
KMMN1005	1000	1075	500
KMMN1205	1200	1075	500

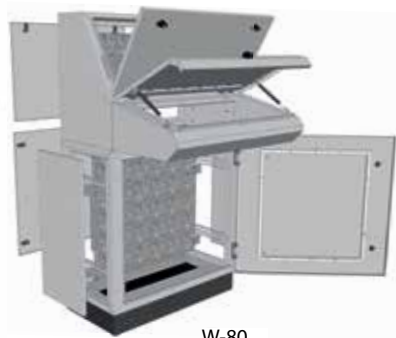
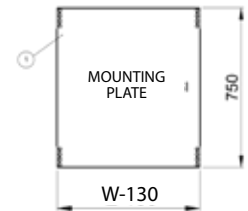
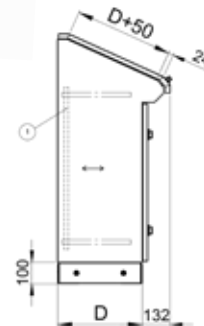
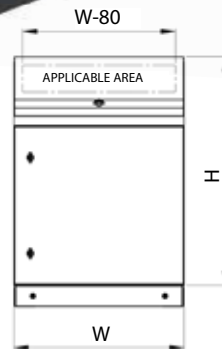

Control Desk Enclosure Piano System

Code	Dimension		
	W	H	D
KMPY0604	600	1325	400
KMPY0804	800	1325	400
KMPY1005	1000	1325	500
KMPY1205	1200	1325	500

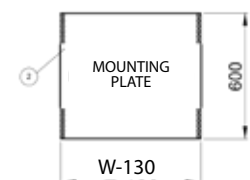
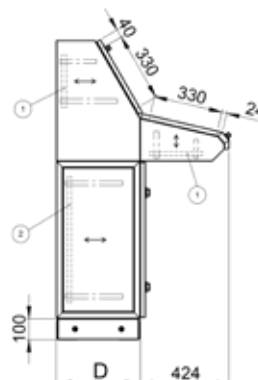
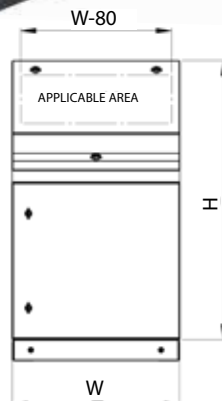

CONTROL PANELS



Technical Characteristic

- Colour Ral7035 Grey
- IK10
- IP40
- Modular body structure
- Mounting System that can be adjusted in depth and High
- Enclosure has bottom cover and base system
- Shock absorber with upper door, provides easily during service and installation
- Removable back and side door feature easy provides mounting plate.



Control Desk Enclosure PC System

Code	Dimension		
	W	H	D
KMPC0604	600	1325	400
KMPC0804	800	1325	400

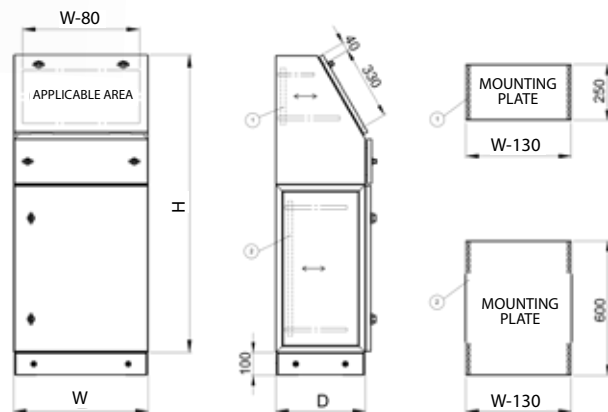

Control Desk Enclosure Modular System

Code	Dimension		
	W	H	D
KMMD0604	600	1075	400
KMMD0804	800	1075	400
KMMD1005	1000	1075	500
KMMD1205	1200	1075	500

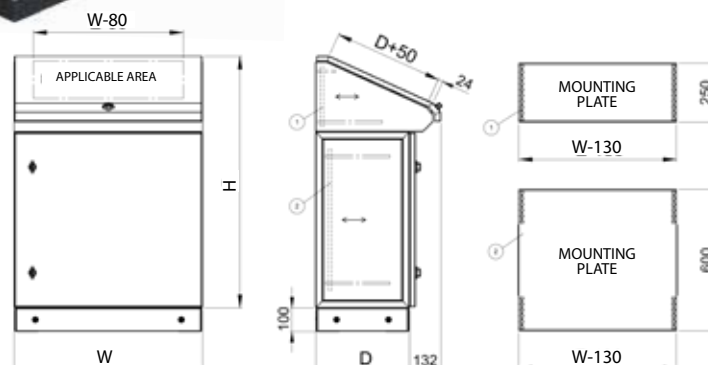

EXTERNAL ENCLOSURES

Technical Characteristic



- Color , RAL7035 Grey
- IP65
- IK10
- Thickness 1.5mm
- Foamed in Door Gasket
- Included Galvanized Mounting Plate

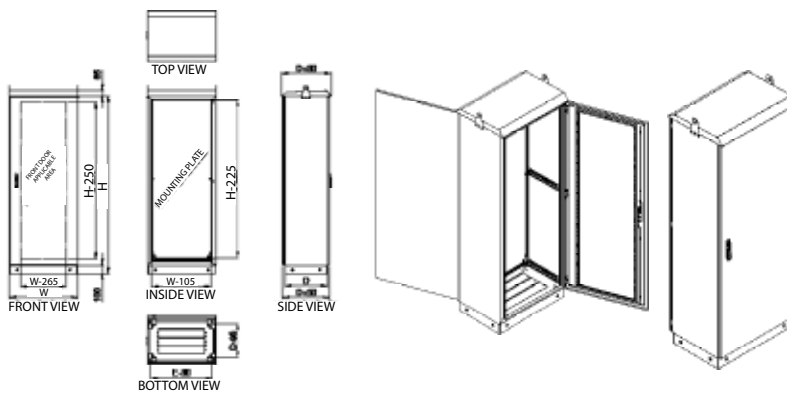

For Floor Installation

Code	Dimension (WxHxD)	Door
CP 158	600x1700x400	1
CP 159	600x1900x500	1
CP 160	600x2100x500	1
CP 163	700x1700x400	1
CP 164	700x1900x500	1
CP 165	700x2100x500	1
CP 168	800x1700x400	1
CP 169	800x1900x500	1
CP 170	800x2100x500	1

METAL JUNCTION BOXES

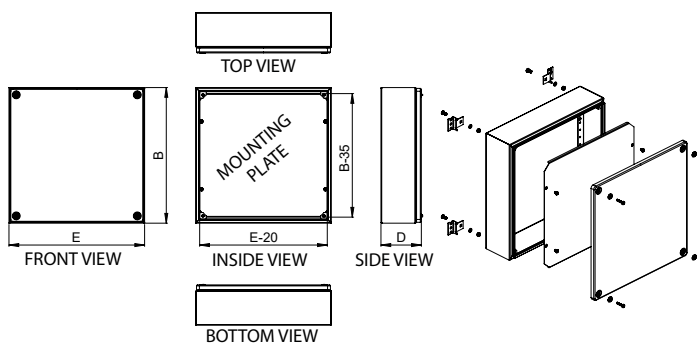

Surface Mounting

Code	Dimension (WxHxD)	Door
CP 1515 T	150x150x120	1
CP 2020 T	200x200x120	1
CP 2520 T	250x200x120	1
CP 3020 T	300x200x120	1
CP 3025 T	300x250x120	1
CP 3030 T	300x300x120	1
CP 4020 T	400x200x120	1
CP 4030 T	400x300x120	1
CP 4040 T	400x400x120	1

*IP54

Flush Mounting

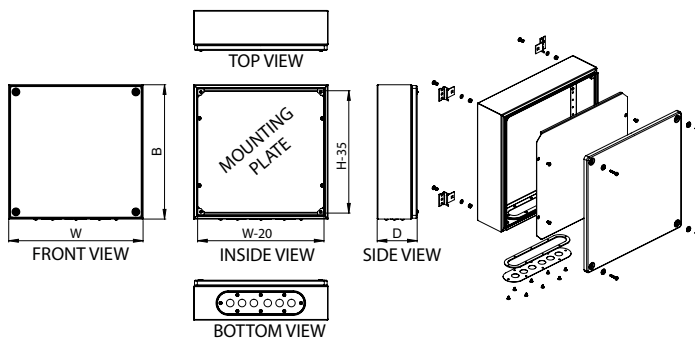

Code	Dimension (WxHxD)	Door
CP 2020 F	200x200x120	1
CP 2520 F	250x200x120	1
CP 3020 F	300x200x120	1
CP 3025 F	300x250x120	1
CP 3030 F	300x300x120	1
CP 4020 F	400x200x120	1
CP 4030 F	400x300x120	1
CP 4040 F	400x400x120	1

*IP54

METAL COMBINATION BOXES

Technical Characteristic



- Colour , RAL7035 Grey
- Thickness 1.20mm
- IP54
- IK10
- Polyurethane Gasket
- Fuse Cover PC Material (Transparent)
- Gland Capacity (PG36)
- Lock Type Stretcher Lock



Metal Combination Box

Code	Dimension (WxHxD)	Description	Door
CP 6500	350x300x160	3 Triphase + 2 Monophase Socket Output	1



Metal Combination Box

Code	Dimension (WxHxD)	Description	Door
CP 6501	350x450x160	6 Triphase + 4 Monophase Socket Output	1

ENCLOSURES FOR CONSTRUCTION SITE INSTALLATION



Enclosures For Construction Site Installation

Code	Dimension (WxHxD)	Description	Door
CP 126	400x980x270	Suitable for 4pcs Triphase , 4pcs Monophase Sockets + 32 Mcb + Blank Cover	1



Enclosures For Construction Site Installation

Code	Dimension (WxHxD)	Description	Door
CP 124	600x700x350	Suitable for 1pcs Triphase Meter , 5pcs Triphase , 5pcs Monophase Sockets + 26 Mcb + Blank Cover	1



Enclosures For Construction Site Installation

Code	Dimension (WxHxD)	Description	Door
CP 129	500x1000x270	Suitable for 1pcs Triphase Meter , 4pcs Triphase , 6pcs Monophase Sockets + 18 Mcb + Blank Cover	1



Enclosures For Construction Site Installation

Code	Dimension (WxHxD)	Description	Door
CP 129 K	500x1500x270	Suitable for 1pcs Triphase Meter , 4pcs Triphase , 6pcs Monophase Sockets + Blank Cover	1



Enclosures For Construction Site Installation

Code	Dimension (WxHxD)	Description	Door
CP 128	400x680x500	Suitable for 9pcs Triphase , 9pcs Monophase Sockets + 48 Mcb + Blank Cover	1

ALUMINIUM JUNCTION BOXES



Aluminum Junction Boxes



Code	Dimension (WxHxD)	Color	Pack
CPAL 1010	101x101x58	RAL 7035	1
CPAL 1311	138,5x113,5x62	RAL 7035	1
CPAL 1614	165,5x140,5x63	RAL 7035	1
CPAL 1816	189x167x30	RAL 7035	1
CPAL 2521	252x215x91	RAL 7035	1
CPAL 3025	307x257x120	RAL 7035	1



Aluminum Junction Boxes

Code	Dimension (WxHxD)	Color	Pack
CPAL 1010 N	101x101x58	Uncolored	1
CPAL 1311 N	138,5x113,5x62	Uncolored	1
CPAL 1614 N	165,5x140,5x63	Uncolored	1
CPAL 1816 N	189x167x30	Uncolored	1
CPAL 2521 N	252x215x91	Uncolored	1
CPAL 3025 N	307x257x120	Uncolored	1



Mounting Plate

Code	Dimension (WxHxD)	Description	Pack
CPAL 1010 MP	80x80	Aluminum Junction Box Mounting Plate	1
CPAL 1311 MP	120x95	Aluminum Junction Box Mounting Plate	1
CPAL 1614 MP	145x120	Aluminum Junction Box Mounting Plate	1
CPAL 1816 MP	165x145	Aluminum Junction Box Mounting Plate	1
CPAL 2521 MP	225x185	Aluminum Junction Box Mounting Plate	1
CPAL 3025 MP	275x220	Aluminum Junction Box Mounting Plate	1

CP BOX POLYESTER PRODUCT RANGE



POLYESTER BOARDS



Technical Characteristic

- Color, RAL 7035 Grey
- Impact Resistant
- Degree of Protection IP 54
- With press-fit cover
- Manufactured in polyester reinforced with fiberglass
- Including 1,00 mm. Mounting plate
- Hinged door which open more than 90°
- Resistant against corrosive ambient
- It is possible to install on the wall, ground or over bases supporting

Blank Door

Code	Dimension (WxHxD)	Pack
CP 501	300 x 200 x 150	1
CP 503	250 x 300 x 155	1
CP 504	300 x 400 x 180	1
CP 505	400 x 500 x 190	1
CP 506	400 x 600 x 200	1
CP 507	500 x 800 x 255	1
CP 508	500 x 800 x 285	1
CP 510	700 x 1100 x 350	1
CP 511	700 x 1000 x 300	1



CP 511



Boards are included with galvanised mounting plate

Plexiglass Door

Code	Dimension (WxHxD)	Pack
CP 522	300 x 400 x 180	1
CP 523	400 x 500 x 190	1
CP 524	400 x 600 x 200	1
CP 525	500 x 800 x 255	1
CP 525 D	500 x 800 x 285	1



Nh Polyester Boards

Code	Dimension (WxHxD)	Pack
CP 515	230X420X120	1
CP 514	230X420X120	1
CP 513	220X420X120	1



Nh Polyester Boards

Code	Dimension (WxHxD)	Pack
CP 516	220X300X120	1
CP 517	300X420X150	1
CP 518	370X580X180	1
CP 519	370X580X180	1



Polyester Boards

Code	Dimension (WxHxD)	Pack
CP 548	160X240X80	1
CP 549	220X300X120	1
CP 550	300X420X150	1
CP 552	370X580X180	1



POLYESTER BOARDS



Polyester Distribution Boards

Code	Dimension (WxHxD)	Din Modules	Pack
CP 530	300 x 400 x 180	10M	1
CP 531	400 x 500 x 190	30M (2x15)	1
CP 532	400 x 600 x 200	45M (3x15)	1
CP 533	500 x 800 x 255	60M (4x15)	1
CP 533D	500 x 800 x 285	60M (4x15)	1



Polyester Triphase Meter Boards

Code	Dimension (WxHxD)	Din Modules	Pack
CP 535	280 x 550 x 200	1Trph. Met. 8M	1
CP 535 E**	280 x 550 x 200	1Trph. Met. 8M	1

** For electronic meter



Polyester Monophase Meter Boards

Code	Dimension (WxHxD)	Din Modules	Pack
CP 537	190 x 370 x 180	1Mnph. Met. 2M	1
CP 537 E**	190 x 370 x 180	1Mnph. Met. 2M	1

** For electronic meter

POLYESTER CABINETS

pedestals



Technical Characteristic

- SMC Material, Glass Fiber Reinforced Polyester
- Empty Cabinets
- Ral 7035 Grey
- IK 10
- IP 44
- Corrasion Resistant
- Easy Connection With Pedestal



Polyester Cabinets

Code	Dimension (WxHxD)	Description	Pack
CP 2642	260 x 420 x 250	Distribution Cabinets	1
CP 2658	260 x 580 x 250	Distribution Cabinets	1
CP 4058	400 x 580 x 250	Distribution Cabinets	1
CP 4084	400 x 840 x 250	Distribution Cabinets	1
CP 5358	530 x 580 x 250	Distribution Cabinets	1
CP 5384	530 x 840 x 250	Distribution Cabinets	1
CP 8084	800 x 840 x 320	Distribution Cabinets	1
CP 10684	1060 x 840 x 320	Distribution Cabinets	1



Pedestal

Code	Dimension (WxHxD)	Description	Pack
CPP 26	260 x 855 x 250	Pedestal for 26 cm Cabinets	1
CPP 40	400 x 855 x 250	Pedestal for 40 cm Cabinets	1
CPP 53	530 x 855 x 250	Pedestal for 53 cm Cabinets	1
CPP 80	800 x 855 x 320	Pedestal for 80 cm Cabinets	1
CPP 106	1060 x 855 x 320	Pedestal for 106 cm Cabinets	1

Cable Base

Code	Dimension (WxHxD)	Description	Pack
CPN 26	260 x 250 x 250	Cable Base for 26 cm	1
CPN 40	400 x 250 x 250	Cable Base for 40 cm	1
CPN 53	530 x 250 x 250	Cable Base for 53 cm	1
CPN 80	800 x 250 x 320	Cable Base for 80 cm	1
CPN 106	1060 x 250 x 320	Cable Base for 106 cm	1
CPDN 26	260 x 250 x 250	Cable Base with Bottom for 26 cm	1
CPDN 40	400 x 250 x 250	Cable Base with Bottom for 40 cm	1
CPDN 53	530 x 250 x 250	Cable Base with Bottom for 53 cm	1
CPDN 80	800 x 250 x 320	Cable Base with Bottom for 80 cm	1
CPDN 106	1060 x 250 x 320	Cable Base with Bottom for 106 cm	1





ACCESSORIES

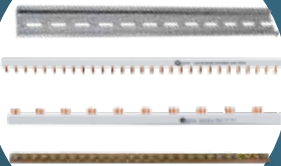

DISTRIBUTION UNITS



2 Pole Distribution Unit

Code	Amper	Description	Pack
200207	80 A	2x7 2 Pole Distribution Unit	1
200211	125 A	2x11 2 Pole Distribution Unit	1
200215	125 A	2x15 2 Pole Distribution Unit	1



200207



200211



200215

4 Pole Distribution Unit

Code	Amper	Description	Pack
200407	125 A	4x7 4 Pole Distribution Unit	1
200411	125 A	4x11 4 Pole Distribution Unit	1
200415	125 A	4x15 4 Pole Distribution Unit	1



200407



200411



200415

Single Pole Distribution Unit

Code	Amper	Description	Pack
201080	80 A	Single Pole Distribution Unit	1
201125	125 A	Single Pole Distribution Unit	1
201160	160 A	Single Pole Distribution Unit	1
201250	250 A	Single Pole Distribution Unit	1
201400	400 A	Single Pole Distribution Unit	1
201500	500 A	Single Pole Distribution Unit	1



201080



201125



201160



201250



201400



201500

ACCESORIES

cable ties

Technical Characteristic

- Advantage of holding multiple cables together reliably
- Flexibility and high strength
- Halogen free quality against flame
- Cold resistant structure with low brittleness
- Strong grip on cable bundles with internal claw structure



PG Cable Glands - Grey

Code	Dimension (L x W) mm	Opening Strength (Kg)	Pcs/ Pack	Pcs/ Cartoon	Colour
CKB 100-2 B	2,5x100	8	100	26.000	White
CKB 150-2 B	2,5x150	8	100	20.000	White
CKB 200-2 B	2,5x200	8	100	18.000	White
CKB 100-3 B	3,5x100	18	100	12.000	White
CKB 140-3 B	3,5x140	18	100	12.000	White
CKB 200-3 B	3,5x200	18	100	10.000	White
CKB 250-3 B	3,5x250	18	100	8.000	White
CKB 280-3 B	3,5x280	18	100	8.000	White
CKB 300-3 B	3,5x300	18	100	8.000	White
CKB 370-3 B	3,5x370	18	100	6.000	White
CKB 200-4 B	4,5x200	22	100	7.000	White
CKB 250-4 B	4,5x250	22	100	6.000	White
CKB 300-4 B	4,5x300	22	100	5.000	White
CKB 370-4 B	4,5x370	22	100	4.000	White
CKB 430-4 B	4,5x430	22	100	3.000	White
CKB 200-7 B	7,5x200	55	100	4.000	White
CKB 300-7 B	7,5x300	55	100	3.000	White
CKB 370-7 B	7,5x370	55	100	2.500	White
CKB 450-7 B	7,5x450	55	100	2.000	White
CKB 550-7 B	7,5x550	55	100	1.500	White
CKB 750-7 B	7,5x750	55	100	1.200	White
CKB 600-9 B	9x600	80	100	1.200	White
CKB 710-9 B	9x710	80	100	1.200	White
CKB 760-9 B	9x760	80	100	1.200	White
CKB 900-9 B	9x900	80	100	1.200	White
CKB 1200-9 B	9x1200	80	100	1.000	White

PG Cable Glands - Black

Code	Dimension (L x W) mm	Opening Strength (Kg)	Pcs/ Pack	Pcs/ Cartoon	Colour
CKB 100-2 S	2,5x100	8	100	26.000	Black
CKB 150-2 S	2,5x150	8	100	20.000	Black
CKB 200-2 S	2,5x200	8	100	18.000	Black
CKB 100-3 S	3,5x100	18	100	12.000	Black
CKB 140-3 S	3,5x140	18	100	12.000	Black
CKB 200-3 S	3,5x200	18	100	10.000	Black
CKB 250-3 S	3,5x250	18	100	8.000	Black
CKB 280-3 S	3,5x280	18	100	8.000	Black
CKB 300-3 S	3,5x300	18	100	8.000	Black
CKB 370-3 S	3,5x370	18	100	6.000	Black
CKB 200-4 S	4,5x200	22	100	7.000	Black
CKB 250-4 S	4,5x250	22	100	6.000	Black
CKB 300-4 S	4,5x300	22	100	5.000	Black
CKB 370-4 S	4,5x370	22	100	4.000	Black
CKB 430-4 S	4,5x430	22	100	3.000	Black
CKB 200-7 S	7,5x200	55	100	4.000	Black
CKB 300-7 S	7,5x300	55	100	3.000	Black
CKB 370-7 S	7,5x370	55	100	2.500	Black
CKB 450-7 S	7,5x450	55	100	2.000	Black
CKB 550-7 S	7,5x550	55	100	1.500	Black
CKB 750-7 S	7,5x750	55	100	1.200	Black
CKB 600-9 S	9x600	80	100	1.200	Black
CKB 710-9 S	9x710	80	100	1.200	White
CKB 760-9 S	9x760	80	100	1.200	White
CKB 900-9 S	9x900	80	100	1.200	White
CKB 1200-9 S	9x1200	80	100	1.000	White



ACCESSORIES



Three Phase Insulated Busbars Pin Type

Code	Amper	Description	Pcs/ Cartoon
CP 4970	63 A	Triphase Busbar 53 cm 1 mm	25
CP 4971	63 A	Triphase Busbar 106 cm 1 mm.	25
CP 4971-1	80 A	Triphase Busbar 53 cm 1 mm.	25
CP 4982	80 A	Triphase Busbar 53 cm 1 mm.	25
CP 4982-1	80 A	Triphase Busbar 106 cm 1 mm.	25
CP 4995		Triphase Busbar Cover	25

Single Phase Insulated Busbars Pin Type

Code	Description	Pcs/ Cartoon
CP 4976	Monophase Busbar 53 cm 1 mm.	50
CP 4977	Monophase Busbar 106 cm 1 mm.	50
CP 4996	Monophase Busbar Cover	50

Earthing Busbar

Code	Description	Pcs/ Cartoon
CP 4974	Earthing Busbar 2 mm. 31 Screws	40
CP 4975	Earthing Busbar 2 mm. 61 Screws	40
CP 4980	Earthing Busbar 1,5 mm. 31 Screws	50
CP 4981	Earthing Busbar 1,5 mm. 61 Screws	30

Din Rails (35x7,5)*

Code	Description	Pcs/ Pack
CP 4983	Galvanized Din Rail Perforated 1 mt.	20
CP 4984	Galvanized Din Rail Perforated 2 mt.	20
CP 4985	Galvanized Din Rail Unperforated 1 mt.	20
CP 4986	Galvanized Din Rail Unperforated 2 mt.	20

Din Rails (35x15)*

Code	Description	Pcs/ Pack
CP 4987	Galvanized Din Rail Perforated 1 mt.	10
CP 4988	Galvanized Din Rail Perforated 2 mt.	10
CP 4989	Galvanized Din Rail Unperforated 1 mt.	10
CP 4990	Galvanized Din Rail Unperforated 2 mt.	10

Din Rail Support

Code	Description	Pcs/ Pack
CP 4991	Din Rail Support	50

ACCESSORIES

Terminal Block Pluggable

Code	Description	Pcs/ Cartoon
10400700010	For Cable 2,5x2 - 2,5 mm ²	5.000
10400700020	For Cable 2,5x3 - 2,5 mm ²	5.000
10400700030	For Cable 2,5x4 - 2,5 mm ²	2.500
10400700040	For Cable 2,5x5 - 2,5 mm ²	2.500



Compact Splicing Connector

Code	Description	Pcs/ Cartoon
10400700050	For Cable 2,5x2 - 2,5 mm ²	10.000
10400700060	For Cable 2,5x3 - 2,5 mm ²	10.000
10400700070	For Cable 2,5x4 - 2,5 mm ²	5.000
10400700090	For Cable 2 - Line 2,5x6 - 2,5 mm ²	5.000
10400700100	For Cable 2 - Line 2,5x4 - 2,5 mm ²	5.000



Adhesive Croches

Code	Description	Color	Pcs/ Packing	Pcs/ Cartoon
CKB 19-19 B	19x19 mm	White	100	20.000
CKB 28-28 B	28x28 mm	White	100	5.000

Adhesive Croches

Code	Description	Color	Pcs/ Packing	Pcs/ Cartoon
CKB 19-19 S	19x19 mm	Black	100	20.000
CKB 28-28 S	28x28 mm	Black	100	5.000





MARINE BOARDS



Technical Characteristic

- Turrets - IP 65 protection
- Resistance to impact IK 09
- Test glow wire 650°C
- Auto-extinguishing degree
- HB (UL94) Dimensional stability
- -25°C + 85°C Ball pressure test 70°C



Marine Boards

Code	Dimension (WxHxD)	Din Modules	Pack
CP 9090	430x890x180	24M	1



FOURLIGHT BOLLARDS



Technical Characteristic

- Aluminum Body
- Ral 7016 Polyester
- Famatel IP68 Socket
- Included screws for ground installation
- Design of shape lets water run off



Fourlight Bollards - Assembled sockets - without led

Code	Dimension (WxHxD)	Description	Pack
CP 8080	80x500x80	2 Pcs. 2x16 Monophase Socket	1
CP 8081	80x500x80	2 Pcs. 2x16 Monophase Socket	1
CP 8082	80x500x80	4 Pcs. 4x16 Monophase Socket	1
CP 8083	80x500x80	4 Pcs. 4x16 Monophase Socket	1

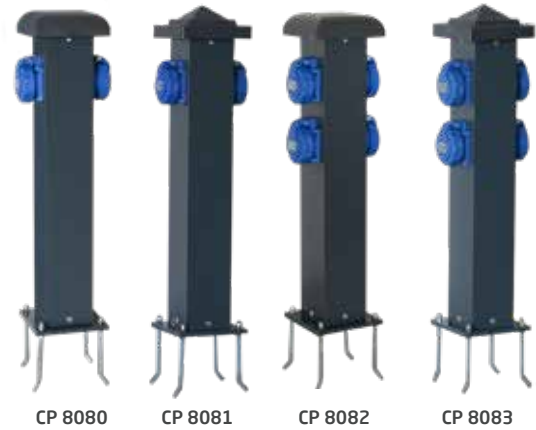

Fourlight Bollards - Assembled sockets - with led

Code	Dimension (WxHxD)	Description	Pack
CP 8080 L	80x500x80	2 Pcs. 2x16 Monophase Socket	1
CP 8081 L	80x500x80	4 Pcs. 4x16 Monophase Socket	1
CP 8082 L	80x500x80	4 Pcs. 4x16 Monophase Socket	1
CP 8083 L	80x500x80	4 Pcs. 4x16 Monophase Socket	1

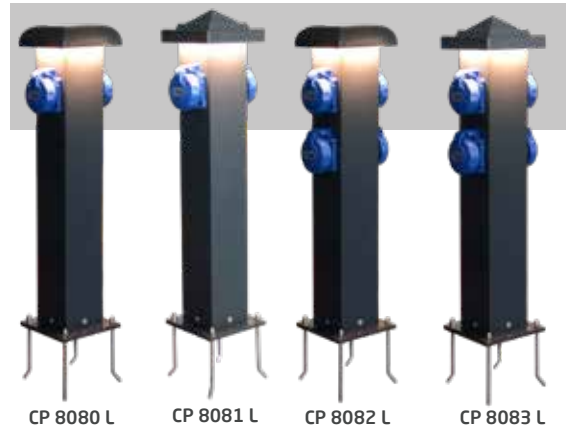

Fourlight Bollards Without socket

Code	Dimension (WxHxD)	Description	Pack
CP 8080 BL	80x500x80	(without socket)	1
CP 8081 BL	80x500x80	(without socket)	1





VENTILATION SYSTEMS



VENTILATION SYSTEM

fans



Pro Compact AC fans

Code	Dimension (WxHxD)	Capacity m ³ /h	Supply 50-60 HZ	Bearing	Current A	Power RPM	Speed RPM	Pack
V04 080 001	80x80x25	36 m ³ /h	220V AC	SLEEVE	0.09	14	2500	1
V04 080 003	80x80x25	36 m ³ /h	110V AC	SLEEVE	0.15	14	2500	1
V04 080 002	80x80x38	43 m ³ /h	220V AC	SLEEVE	0.06	9	2750	1



Pro Compact AC fans

Code	Dimension (WxHxD)	Capacity m ³ /h	Supply 50-60 HZ	Bearing	Current A	Power RPM	Speed RPM	Pack
V04 092 002	92x92x25	57 m ³ /h	220V AC	SLEEVE	0.09	15	2600	1
V04 092 001	92x92x38	72 m ³ /h	220V AC	SLEEVE	0.06	9	2550	1
V04 092 003	92x92x38	72 m ³ /h	110V AC	SLEEVE	0.21	15	2550	1



Pro Compact AC fans

Code	Dimension (WxHxD)	Capacity m ³ /h	Supply 50-60 HZ	Bearing	Current A	Power RPM	Speed RPM	Pack
V04 120 002	120x120x25	121 m ³ /h	220V AC	SLEEVE	0.09	15	2500	1
V04 120 009*	120x120x38	179 m ³ /h	220V AC	BALL	0.16	26	2800	1
V04 120 005**	120x120x38	163 m ³ /h	220V AC	SLEEVE	0.13	20	2800	1
V04 120 001	120x120x38	163 m ³ /h	110V AC	SLEEVE	0.36	26	2800	1
V04 120 006	120x120x38	163 m ³ /h	220V AC	BALL	0.13	20	2800	1

* 7 Wings ** Terminal Connection



Pro Compact AC fans (Metal Wing)

Code	Dimension (WxHxD)	Capacity m ³ /h	Supply 50-60 HZ	Bearing	Current A	Power RPM	Speed RPM	Pack
V04 120 003	120x120x38	192 m ³ /h	220V AC	BALL	0.15	24	2800	1
V04 120 008 *	120x120x38	192 m ³ /h	220V AC	BALL	0.15	24	2800	1
V04 120 007	120x120x38	192 m ³ /h	110V AC	BALL	0.21	24	2800	1

* Terminal Connection



Pro Compact AC fans

Code	Dimension (WxHxD)	Capacity m ³ /h	Supply 50-60 HZ	Bearing	Current A	Power RPM	Speed RPM	Pack
V04 135 001	135x135x38	212 m ³ /h	220V AC	BALL	0.18	22	2850	1

Pro Compact AC fans

Code	Dimension (WxHxD)	Capacity m ³ /h	Supply 50-60 HZ	Bearing	Current A	Power RPM	Speed RPM	Pack
V04 150 001	150x150x50	339 m ³ /h	220V AC	BALL	0.19	25	2700	1



Pro Compact AC fans

Code	Dimension (WxHxD)	Capacity m ³ /h	Supply 50-60 HZ	Bearing	Current A	Power RPM	Speed RPM	Pack
V04 170 001 *	170x150x55	353 m ³ /h	220V AC	BALL	0.23	33	2950	1
V04 170 002 *	170x150x55	353 m ³ /h	110V AC	BALL	0.54	41	2950	1

VENTILATION SYSTEM

fans

Pro Compact AC Fans



Code	Dimension (WxHxD)	Description	Supply 50-60 HZ	Bearing	Current A	Power RPM	Speed RPM	Pack
V04 172 002	172x150x51	361 m3/h	220V AC	BALL	0.21	34	2900	1
V04 172 001	172X150X51	361 m3/h	110V AC	BALL	0.47	36	2900	1

Pro Compact AC Fans



Code	Dimension (WxHxD)	Description	Supply 50-60 HZ	Bearing	Current A	Power RPM	Speed RPM	Pack
V04 180 001	180x180x65	629 m3/h	220V AC	BALL	0.22	45	2800	1

Pro Compact AC Fans



Code	Dimension (WxHxD)	Description	Supply 50-60 HZ	Bearing	Current A	Power RPM	Speed RPM	Pack
V04 200 001	200x200x60	650 m3/h	220V AC	BALL	0.48	68	2550	1

Pro Compact AC fans



Code	Dimension (WxHxD)	Description	Supply 50-60 HZ	Bearing	Current A	Power RPM	Speed RPM	Pack
V04 220 001	Ø220x60	650 m3/h	220V AC	BALL	0.32	48	2600	1

Pro Compact AC Fans (Metal Wing)



Code	Dimension (WxHxD)	Description	Supply 50-60 HZ	Bearing	Current A	Power RPM	Speed RPM	Pack
V04 225 001	225x225x80	1.020 m3/h	220V AC	BALL	0.31	70	2650	1
V04 225 002	225x225x80	1.020 m3/h	110V AC	BALL	0.67	70	2650	1

Pro Compact AC Fans (Metal Wing)



Code	Dimension (WxHxD)	Description	Supply 50-60 HZ	Bearing	Current A	Power RPM	Speed RPM	Pack
V04 280 001	280x280x80	1.917 m3/h	220V AC	BALL	0.60	135	2600	1
V04 280 002	280x280x80	1.917 m3/h	110V AC	BALL	1.20	135	2600	1

VENTILATION SYSTEM



Pro Compact DC Fans



Code	Dimension (WxHxD)	Description	Supply	Bearing	Current A	Power RPM	Speed RPM	Pack
V05 040 001	40x40x10	18 m3/h	12V DC	SLEEVE	0.10	1.2	7500	1
V05 040 002	40x40x10	18 m3/h	24V DC	SLEEVE	0.08	1.92	7500	1

Pro Compact DC Fans



Code	Dimension (WxHxD)	Description	Supply	Bearing	Current A	Power RPM	Speed RPM	Pack
V05 050 001	50x50x10	23 m3/h	12V DC	SLEEVE	0.10	1.2	6000	1
V05 050 002	50x50x10	23 m3/h	24V DC	SLEEVE	0.06	1.92	6000	1

Pro Compact DC Fans



Code	Dimension (WxHxD)	Description	Supply	Bearing	Current A	Power RPM	Speed RPM	Pack
V05 060 001	60x60x25	37 m3/h	12V DC	SLEEVE	0.19	2.4	4500	1
V05 060 002	60x60x25	37 m3/h	24V DC	SLEEVE	0.11	2.4	4500	1

Pro Compact DC Fans



Code	Dimension (WxHxD)	Description	Supply	Bearing	Current A	Power RPM	Speed RPM	Pack
V05 080 002	80x80x25	69 m3/h	12V DC	SLEEVE	0.3	3.6	3500	1
V05 080 001	80x80x25	69 m3/h	24V DC	SLEEVE	0.15	3.6	3500	1

Pro Compact DC Fans



Code	Dimension (WxHxD)	Description	Supply	Bearing	Current A	Power RPM	Speed RPM	Pack
V05 092 001	92x92x25	103 m3/h	12V DC	SLEEVE	0.36	4.2	3500	1
V05 092 002	92x92x25	103 m3/h	24V DC	SLEEVE	0.21	5.5	3500	1

Pro Compact DC Fans



Code	Dimension (WxHxD)	Description	Supply	Bearing	Current A	Power RPM	Speed RPM	Pack
V05 120 001	120x120x25	148 m3/h	12V DC	SLEEVE	0.45	5.40	3200	1
V05 120 002	120x120x25	148 m3/h	24V DC	SLEEVE	0.25	6	3200	1
V05 120 005	120x120x38	166 m3/h	12V DC	SLEEVE	0.3	3.6	2500	1
V05 120 003	120x120x38	166 m3/h	24V DC	SLEEVE	0.2	4.8	2500	1
V05 120 004	120x120x38	166 m3/h	48V DC	BALL	0.1	4.8	2500	1

Pro Compact DC Fans



Code	Dimension (WxHxD)	Description	Supply	Bearing	Current A	Power RPM	Speed RPM	Pack
V05 172 001	172x150x51	365 m3/h	12V DC	BALL	2.6	31.2	3000	1
V05 172 002	172x150x51	365 m3/h	24V DC	BALL	1.3	31.2	3000	1

VENTILATION SYSTEM

eco compact fans



ECO Compact Axial Fans

Code	Dimension	Supply	Connection	Pack
BRZ 01	120x120x25	220 VAC	With Cable	1
BRZ 02	120x120x38	220 VAC	With Cable	1
BRZ 03	120x120x38	220 VAC	With Socket	1
BRZ 04	120x120x25	12 VDC	With Cable	1
BRZ 05	120x120x25	24 VDC	With Cable	1
BRZ 06	120x120x38	12 VDC	With Cable	1
BRZ 07	120x120x38	24 VDC	With Cable	1
BRZ 08	120x120x38	110 VAC	With Cable	1
BRZ 09	120x120x38	48 VDC	With Cable	1
BRZ 10	90x90x25	220 VAC	With Cable	1
BRZ 11	90x90x38	220 VAC	With Cable	1
BRZ 12	90x90x25	12 VDC	With Cable	1
BRZ 13	90x90x25	24 VDC	With Cable	1
BRZ 14	80x80x38	220 VAC	With Cable	1
BRZ 15	80x80x25	220 VAC	With Cable	1
BRZ 16	80x80x25	12 VDC	With Cable	1
BRZ 17	80x80x25	24 VDC	With Cable	1
BRZ 18	60x60x20	24 VDC	With Cable	1
BRZ 19	50x50x10	24 VDC	With Cable	1
BRZ 20	40x40x10	24 VDC	With Cable	1



ECO Compact Axial Fans

Code	Dimension	Supply	Connection	Pack
BRZ 21	172x150x51	220 VAC	With Cable	1
BRZ 22	172x150x51	24 VDC	With Cable	1
BRZ 23	172x150x51	115 VAC	With Cable	1



ECO Compact Axial Fans

Code	Dimension	Supply	Connection	Pack
BRZ 24	Ø220x60	220 VAC	With Cable	1

VENTILATION SYSTEM

filters



FM Series Easy Install Grilles

Code	Description	Pack
V02 110 003	110x110 GRAY GRILLE	1
V02 110 004	110x110 BLACK GRILLE	1



FM Series Easy Install Grilles

Code	Description	Pack
V02 160 003	160x160 GRAY GRILLE	1
V02 160 004	160x160 BLACK GRILLE	1



FM Series Easy Install Grilles

Code	Description	Pack
V02 210 003	210x210 GRAY GRILLE	1
V02 210 004	210x210 BLACK GRILLE	1



FM Series Easy Install Grilles

Code	Description	Pack
V02 260 003	260x260 GRAY GRILLE	1
V02 260 004	260x260 BLACK GRILLE	1



FM Series Easy Install Grilles

Code	Description	Pack
V02 325 003	325x325 GRAY GRILLE	1
V02 325 004	325x325 BLACK GRILLE	1

VENTILATION SYSTEM

filters

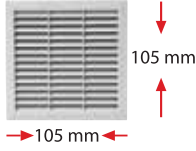

FME Series Easy Install Grilles

Code	Description	Pack
V02 110 001	105x105 GRAY GRILLE	1
V02 110 002	105x105 BLACK GRILLE	1

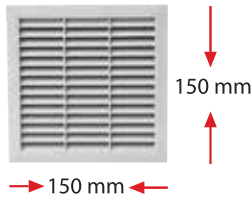

FME Series Easy Install Grilles

Code	Description	Pack
V02 160 001	150x150 GRAY GRILLE	1
V02 160 002	150x150 BLACK GRILLE	1

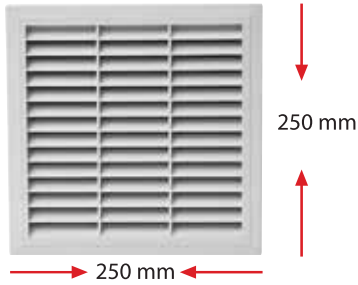

FME Series Easy Install Grilles

Code	Description	Pack
V02 260 001	250x250 GRAY GRILLE	1
V02 260 002	250x250 BLACK GRILLE	1

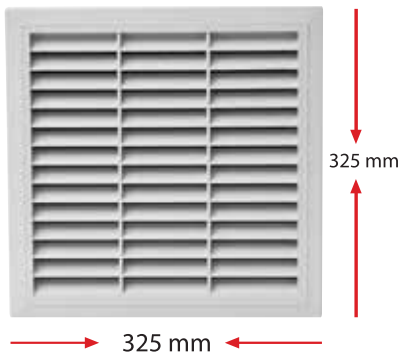

FME Series Easy Install Grilles

Code	Description	Pack
V02 325 001	325x325 GRAY GRILLE	1
V02 325 002	325x325 BLACK GRILLE	1

VENTILATION SYSTEM

fan filters



Fan Filters

Code	Grill	Fan	Filtered m3/h	Unfiltered m3/h	Supply	Pack
V01 110 001	105x105	80x80x38	34	43	230V-50/60Hz	1



Fan Filters

Code	Grill	Fan	Filtered m3/h	Unfiltered m3/h	Supply	Pack
V01 160 001	150x150	120x120x38	130	163	230V-50/60Hz	1



Fan Filters

Code	Grill	Fan	Filtered m3/h	Unfiltered m3/h	Supply	Pack
V01 210 001	210x210	120x120x38	130	163	230V-50/60Hz	1



Fan Filters

Code	Grill	Fan	Filtered m3/h	Unfiltered m3/h	Supply	Pack
V01 260 001	250x250	120x120x38	130	163	230V-50/60Hz	1



Fan Filters

Code	Grill	Fan	Filtered m3/h	Unfiltered m3/h	Supply	Pack
V01 260 002	250x250	170x150x55	285	350	230V-50/60Hz	1
V01 260 003	250x250	172x150x51	288	361	230V-50/60Hz	1



Fan Filters

Code	Grill	Fan	Filtered m3/h	Unfiltered m3/h	Supply	Pack
V01 260 004	250x250	225x225x80	755	944	230V-50/60Hz	1



Fan Filters

Code	Grill	Fan	Filtered m3/h	Unfiltered m3/h	Supply	Pack
V01 325 001	325x325	220x60	520	650	230V-50/60Hz	1



Fan Filters

Code	Grill	Fan	Filtered m3/h	Unfiltered m3/h	Supply	Pack
V01 325 002	325x325	280x280x80	1533	1917	230V-50/60Hz	1

VENTILATION SYSTEM

fan filters



Fan Filters

Code	Grill	Fan	Filtered m3/h	Unfiltered m3/h	Supply	Pack
V01 110 002	105x105	80x80x25	29	36	110V-50/60Hz	1



Fan Filters

Code	Grill	Fan	Filtered m3/h	Unfiltered m3/h	Supply	Pack
V01 160 002	150x150	120x120x38	130	163	110V-50/60Hz	1



Fan Filters

Code	Grill	Fan	Filtered m3/h	Unfiltered m3/h	Supply	Pack
V01 260 005	250x250	172x150x51	288	361	110V-50/60Hz	1



Fan Filters

Code	Grill	Fan	Filtered m3/h	Unfiltered m3/h	Supply	Pack
V01 260 006	250x250	170x150x55	282	353	110V-50/60Hz	1



Fan Filters

Code	Grill	Fan	Filtered m3/h	Unfiltered m3/h	Supply	Pack
V01 260 010	250x250	225x225x80	800	1.020	110V-50/60Hz	1

VENTILATION SYSTEM

fan filters



Fan Filters

Code	Grill	Fan	Filtered m3/h	Unfiltered m3/h	Supply	Pack
V01 110 003	105x105	80x80x25	55	69	24V DC	1



Fan Filters

Code	Grill	Fan	Filtered m3/h	Unfiltered m3/h	Supply	Pack
V01 160 003	150x150	120x120x38	132	166	24V DC	1



Fan Filters

Code	Grill	Fan	Filtered m3/h	Unfiltered m3/h	Supply	Pack
V01 260 007	250x250	120x120x38	132	166	24V DC	1



Fan Filters

Code	Grill	Fan	Filtered m3/h	Unfiltered m3/h	Supply	Pack
V01 260 008	250x250	172x150x51	288	361	24V DC	1

VENTILATION SYSTEM

roof fans

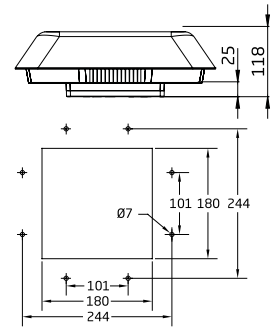
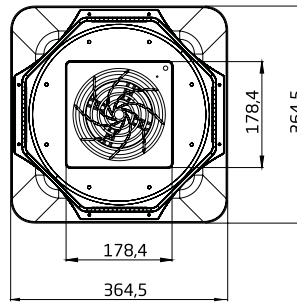

Roof fans (Screw Connection)

Code	Dimension (WxHxD)	Description	Supply	Pack
V03 160 001	172x150x51	350 m3/h	230V-50/60Hz	1
V03 162 001	170x150x55	350 m3/h	230V-50/60Hz	1
V03 162 002	172x150x51	350 m3/h	110V-50/60Hz	1
V03 175 001	Ø175 Radial	470 m3/h	230V-50/60Hz	1
V03 190 001	Ø190 Radial	600 m3/h	230V-50/60Hz	1
V03 220 001	Ø220 Radial	1000 m3/h	230V-50/60Hz	1

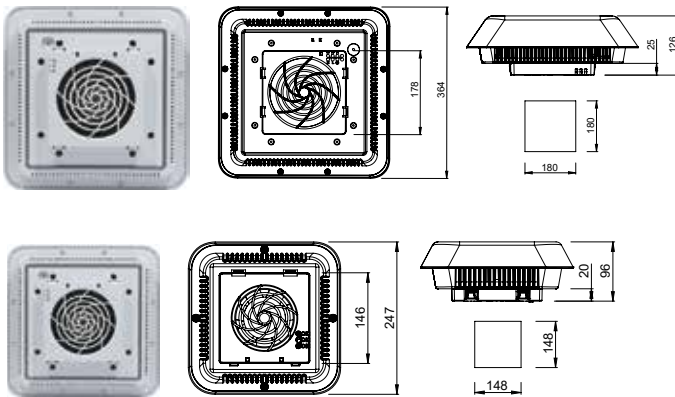

Un Filtered IP20 Roof Fans (Quick Connection)

Code	Dimension (WxHxD)	Description	Supply	Pack
V03 160 003	172x150x51	350 m3/h	230V-50/60Hz	1
V03 162 004	170x150x55	350 m3/h	230V-50/60Hz	1
V03 162 006	172x150x51	350 m3/h	110V-50/60Hz	1
V03 175 003	Ø175 Radial	470 m3/h	230V-50/60Hz	1
V03 190 006	Ø190 Radial	600 m3/h	230V-50/60Hz	1
V03 220 006	Ø 220 Radial	1000 m3/h	230V-50/60Hz	1
V03 120 001	120x120x38	180 m3/h	230V-50/60Hz	1
V03 133 001	Ø133 Radial	230 m3/h	230V-50/60Hz	1

V03 120 001

V03 133 001

IP54 With Filtered Roof Fans (Quick Connection)

Code	Dimension (WxHxD)	Description	Supply	Pack
V03 160 002	172x150x51	350 m3/h	230V-50/60Hz	1
V03 162 003	170x150x55	350 m3/h	230V-50/60Hz	1
V03 175 002	Ø175 RADYAL	470 m3/h	230V-50/60Hz	1
V03 190 002	Ø190 RADYAL	600 m3/h	230V-50/60Hz	1
V03 220 002	Ø220 RADYAL	1000 m3/h	230V-50/60Hz	1

VENTILATION SYSTEM

metal fans

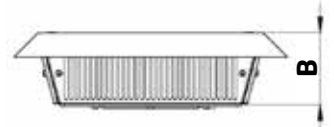
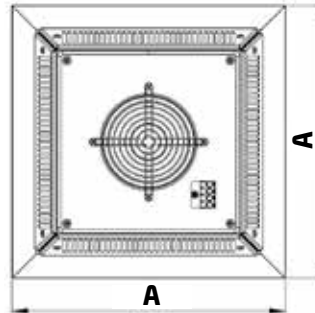

Metal Fans (With Filtered)

Code	Dimension	A	B	Pack
V03 190 005	190 mm-600 m ³	400	105	1
V03 220 005	220 mm-1000 m ³	400	105	1
V03 250 003	250 mm-1300 m ³	461	115	1

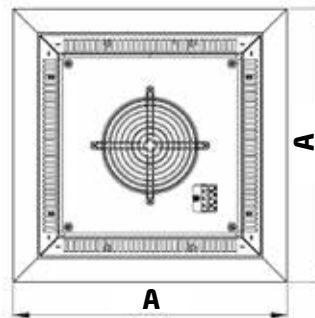

Metal Fans (UnFiltered)

Code	Dimension	A	B	Pack
V03 190 004	190 mm-600 m ³	400	105	1
V03 220 004	220 mm-1000 m ³	400	105	1
V03 250 002	250 mm-1300 m ³	461	115	1

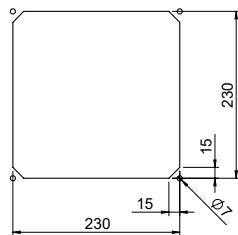

V03 190 004
V03 190 005
V03 220 004
V03 220 005

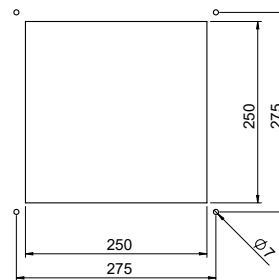

V03 250 002
V03 250 003

VENTILATION SYSTEM

thermostats



Fan Thermostats

Code	Description	Description	Pack
V10 01M 001	Fan Thermostat	INO	1



Heater Thermostats

Code	Description	Description	Pack
V10 02K 001	Heater Thermostat	INC	1



Dual Thermostats

Code	Description	Description	Pack
V10 05M 001	Fan+Heater Thermostat	INO + INC	1



Hygrostats

Code	Description	Description	Pack
V10 03H 001	Hygrometer	ICO	1



Room Thermostats

Code	Description	Pack
V10 04R 001	Room Thermostat	1

VENTILATION SYSTEM

panel heaters



Panel Heaters - MPH Series

Code	Description	Supply	Pack
V11 015 001	15 W Panel Heater	110-250V AC / DC	1
V11 025 001	25 W Panel Heater	110-250V AC / DC	1



Panel Heaters - PH Series

Code	Description	Supply	Pack
V11 030 001	30 W Panel Heater	110-250V AC / DC	1
V11 045 001	45 W Panel Heater	110-250V AC / DC	1
V11 060 001	60 W Panel Heater	110-250V AC / DC	1
V11 075 001	75 W Panel Heater	110-250V AC / DC	1
V11 100 001	100 W Panel Heater	110-250V AC / DC	1
V11 150 001	150 W Panel Heater	110-250V AC / DC	1



Panel Heaters with fan - PFH Series

Code	Description	Supply	Pack
V12 250 001	250 W Panel Heater	220-240V AC	1
V12 400 001	400 W Panel Heater	220-240V AC	1

VENTILATION SYSTEM

fans

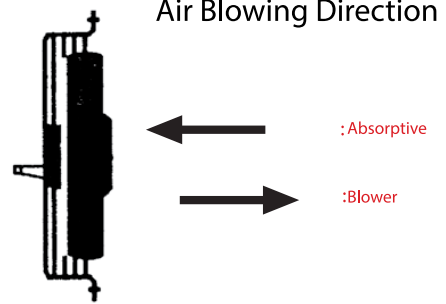

Axial Absorptive Fans

Code	Description	Speed	Capacity	Supply	Pack
V07 250 001	65W	1400 RPM	1530 m3/h	220-240 VAC	1
V07 300 001	115W	1400 RPM	1900 m3/h	220-240 VAC	1
V07 350 001	190W	1400 RPM	3550 m3/h	220-240 VAC	1
V07 400 001	260W	1400 RPM	4450 m3/h	220-240 VAC	1
V07 450 001	360W	1400 RPM	5800 m3/h	220-240 VAC	1
V07 500 001	420W	1400 RPM	6950 m3/h	220-240 VAC	1
V07 550 001	550W	1400 RPM	8500 m3/h	220-240 VAC	1

Axial Blower Fans

Code	Description	Speed	Capacity	Supply	Pack
V08 250 001	65W	1400 RPM	1530 m3/h	220-240 VAC	1
V08 300 001	115W	1400 RPM	1900 m3/h	220-240 VAC	1
V08 350 001	190W	1400 RPM	3550 m3/h	220-240 VAC	1
V08 400 001	260W	1400 RPM	4450 m3/h	220-240 VAC	1
V08 450 001	360W	1400 RPM	5800 m3/h	220-240 VAC	1
V08 500 001	420W	1400 RPM	6950 m3/h	220-240 VAC	1
V08 550 001	550W	1400 RPM	8500 m3/h	220-240 VAC	1

Turbo Fans - TRF Series

Code	Description	Speed	Capacity	Supply	Pack
V09 180 001	18W	1850	150 m3/h	220-240 VAC	1
V09 240 001	26W	2450	170 m3/h	220-240 VAC	1



VENTILATION SYSTEM

ventilation system accesories

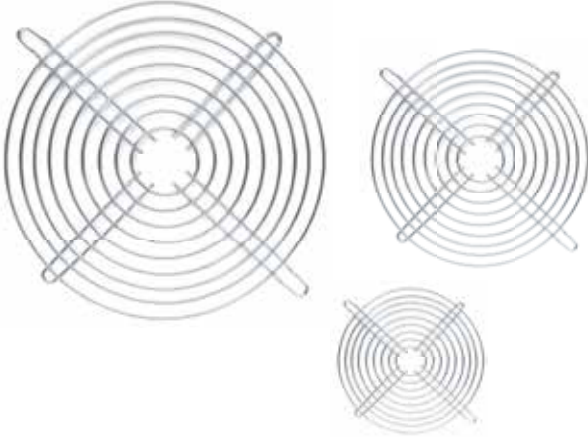

Metal Fan Protection Wires - VT Series

Code	Dimensions	Pack
V13 080 001	80x80 mm	100
V13 090 001	90x90 mm	100
V13 120 001	120x120 mm	100
V13 170 001	170x170 mm	100
V13 225 001	225x225 mm	100
V13 280 001	280x280 mm	100

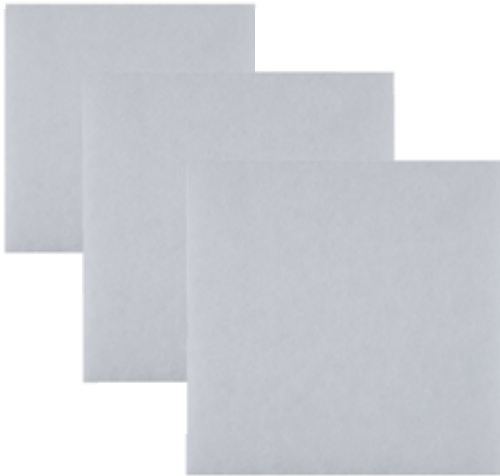

Filters - VFM Series

Code	Dimensions	Pack
V14 110 001	110x110 mm	10
V14 150 001	150x150 mm	10
V14 210 001	210x210 mm	10
V14 250 001	250x250 mm	10
V14 325 001	325x325 mm	10



Project Board

Code	Description
V15 A4 001	A4 Project Board
V15 A5 001	A5 Project Board



CP CABLING
ALUMINIUM PRODUCT
RANGE



CABLE REELS

metal & plastic

Cable Carrier

Code	Product	Cable	
CP 001	4 Monophase Socket Output / Metal Body	3 x 2,5 50 meter capacity	Empty
CP 002	3 Monophase with Cover Socket Output / Metal Body	3 x 1,5 meter capacity	Empty
CP 011	2 Monophase+ 1 Triphase with Cover (3x25) Socket Output / Metal Body	4 x 2,5 50 meter capacity	Empty
CP 012	2 Monophase + 1 Triphase with Cover / (5x32) Socket Output Metal Body	4 x 2,5 50 meter capacity	Empty
CP 013	4 Monophase Socket Output / Metal Body	4 x 2,5 50 meter capacity	Empty
CP 090	4 Monophase Socket Output / Plastic Body	3 x 1,5 30 meter capacity	Empty
CP 091	4 Monophase Socket Output / Plastic Body	3 x 1,5 50 meter capacity	Empty



FLOOR BOXES

Technical Characteristic

- Ral 7037
- Polycarbonate
- 8 and 16 Module

Floor Boxes

Code	Module	
500807	8	Empty
501607	16	Empty



500807



501607

Adjustable metal box for concrete floor

Code	Module	
500800	8	Empty
501600	16	Empty



500800



501600



501607 + 501600



500807 + 500800

ALUMINIUM SOCKET MODELS



Assambled Aluminium Socket Models

Code	Description	Color	Raw Material	Pack
1103101	3 Sockets + 1 mcb + 1 mt. Cable Assambled Aluminium Socket Models	Grey	ABS+Alum.	1
1103103	3 Sockets + 1 mcb + 1 mt. Cable Assambled Aluminium Socket Models	Black	ABS+Alum.	1
1106101	6 Sockets + 1 mcb + 1 mt. Cable Assambled Aluminium Socket Models	Grey	ABS+Alum.	1
1106103	6 Sockets + 1 mcb + 1 mt. Cable Assambled Aluminium Socket Models	Black	ABS+Alum.	1
1103201	3 Sockets + 1 Usb + 1 Type C+1 mt. Cable Assambled Aluminium Socket Models	Grey	ABS+Alum.	1
1104203	4 Sockets + 2 Usb + 2 Type C+1 mt. Cable Assambled Aluminium Socket Models	Black	ABS+Alum.	1



1103103



1103201



1104203

Aluminium Socket Models

Code	Module	Color	Raw Material	Pack
P09 04 02	4	Black	ABS+Alum.	1
P09 06 02	6	Black	ABS+Alum.	1
P09 08 02	8	Black	ABS+Alum.	1
P09 10 02	10	Black	ABS+Alum.	1
P09 12 02	10	Black	ABS+Alum.	1
P09 14 02	14	Black	ABS+Alum.	1
P09 16 02	16	Black	ABS+Alum.	1
P09 04 01	4	Grey	ABS+Alum.	1
P09 06 01	6	Grey	ABS+Alum.	1
P09 08 01	8	Grey	ABS+Alum.	1
P09 10 01	10	Grey	ABS+Alum.	1
P09 12 01	10	Grey	ABS+Alum.	1
P09 14 01	14	Grey	ABS+Alum.	1
P09 16 01	16	Grey	ABS+Alum.	1



ALUMINIUM TABLE SOCKETS BOX



Aluminium Table Sockets Box

Code	Module	Color	Raw Material	Pack
P01 05 01	5	Grey	ABS+Alum.	1
P01 05 02	5	Black	ABS+Alum.	1
P01 05 03	5	White	ABS+Alum.	1
P01 05 04	5	Anthracite	ABS+Alum.	1
new P01 06 01	6	Grey	ABS+Alum.	1
new P01 06 02	6	Black	ABS+Alum.	1
new P01 06 03	6	White	ABS+Alum.	1
new P01 06 04	6	Anthracite	ABS+Alum.	1
P01 08 01	8	Grey	ABS+Alum.	1
P01 08 02	8	Black	ABS+Alum.	1
P01 08 03	8	White	ABS+Alum.	1
P01 08 04	8	Anthracite	ABS+Alum.	1
P01 10 01	10	Grey	ABS+Alum.	1
P01 10 02	10	Black	ABS+Alum.	1
P01 10 03	10	White	ABS+Alum.	1
P01 10 04	10	Anthracite	ABS+Alum.	1
P01 12 01	12	Grey	ABS+Alum.	1
P01 12 02	12	Black	ABS+Alum.	1
P01 12 03	12	White	ABS+Alum.	1
P01 12 04	12	Anthracite	ABS+Alum.	1
P01 16 01	16	Grey	ABS+Alum.	1
P01 16 02	16	Black	ABS+Alum.	1
P01 16 03	16	White	ABS+Alum.	1
P01 16 04	16	Anthracite	ABS+Alum.	1
P01 20 01	20	Grey	ABS+Alum.	1
P01 20 02	20	Black	ABS+Alum.	1
P01 20 03	20	White	ABS+Alum.	1
P01 20 04	20	Anthracite	ABS+Alum.	1

Cylinder - Aluminium Socket Strips with Data Socket

Code	Module	Color	Raw Material	Pack
P03 06 05	6	Inox	ABS+Alum+Stainless	1
P03 06 02	6	Black	ABS+Alum+Stainless	1
P03 06 06	6	Bronze	ABS+Alum+Stainless	1
P03 06 07	6	Gold	ABS+Alum+Stainless	1
P03 08 05	8	Inox	ABS+Alum+Stainless	1
P03 08 02	8	Black	ABS+Alum+Stainless	1
P03 08 06	8	Bronze	ABS+Alum+Stainless	1
P03 08 07	8	Gold	ABS+Alum+Stainless	1
P03 10 05	10	Inox	ABS+Alum+Stainless	1
P03 10 02	10	Black	ABS+Alum+Stainless	1
P03 10 06	10	Bronze	ABS+Alum+Stainless	1
P03 10 07	10	Gold	ABS+Alum+Stainless	1

Cylinder - Aluminium Socket Strips without Data Sockets

Code	Module	Color	Raw Material	Pack
P04 06 01	6	Grey	AL+HRP	1
P04 08 01	8	Grey	AL+HRP	1
P04 10 01	10	Grey	AL+HRP	1
P04 12 01	12	Grey	AL+HRP	1
P04 14 01	14	Grey	AL+HRP	1
P04 16 01	16	Grey	AL+HRP	1
P04 18 01	18	Grey	AL+HRP	1
P04 20 01	20	Grey	AL+HRP	1
P04 22 01	22	Grey	AL+HRP	1
P04 24 01	24	Grey	AL+HRP	1
P04 26 01	26	Grey	AL+HRP	1

ALUMINIUM MODULES

Pop-up Type Flush Mounting Boxes

Code	Module	Color	Raw Material	Pack
800401	4	Silver	Aluminum POP-UP	1
800402	4	Black	Aluminum POP-UP	1
800801	8	Silver	Aluminum POP-UP	1
800802	8	Black	Aluminum POP-UP	1



Flush-Metal Boxes

Code	Module	Color	Raw Material	Pack
008004	4	Black	Aluminum POP-UP	1
008008	8	Black	Aluminum POP-UP	1



Aluminium Modules

Code	Module	Color	Raw Material	Pack
P10 04 02	4	Black	ABS+Alum.	1
P10 06 02	6	Black	ABS+Alum.	1
P10 08 02	8	Black	ABS+Alum.	1
P10 10 02	10	Black	ABS+Alum.	1
P10 12 02	12	Black	ABS+Alum.	1
P10 14 02	14	Black	ABS+Alum.	1
P10 16 02	16	Black	ABS+Alum.	1
P10 04 01	4	Grey	ABS+Alum.	1
P10 06 01	6	Grey	ABS+Alum.	1
P10 08 01	8	Grey	ABS+Alum.	1
P10 10 01	10	Grey	ABS+Alum.	1
P10 12 01	12	Grey	ABS+Alum.	1
P10 14 01	14	Grey	ABS+Alum.	1
P10 16 01	16	Grey	ABS+Alum.	1



Aluminium Socket Models

Code	Module	Color	Raw Material	Pack
P02 05 01	5	Grey	ABS+Alum.	1
P02 05 02	5	Black	ABS+Alum.	1
P02 05 03	5	White	ABS+Alum.	1
P02 08 01	8	Grey	ABS+Alum.	1
P02 08 02	8	Black	ABS+Alum.	1
P02 08 03	8	White	ABS+Alum.	1
P02 12 01	12	Grey	ABS+Alum.	1
P02 12 02	12	Black	ABS+Alum.	1
P02 12 03	12	White	ABS+Alum.	1
P02 16 01	16	Grey	ABS+Alum.	1
P02 16 02	16	Black	ABS+Alum.	1
P02 16 03	16	White	ABS+Alum.	1
P02 20 01	20	Grey	ABS+Alum.	1
P02 20 02	20	Black	ABS+Alum.	1
P02 20 03	20	White	ABS+Alum.	1



SOCKETS



Sockets (Direct Cable Connection)

Code	Module	Description	Color	Raw Materail	Pack
P08 01 03	1	5v 1100 mA Output Usb Socket A Type	White	PC	12
P08 02 03	2	5v 2400 mA Output Usb Socket A+A	White	PC	6
P08 01 02	1	5v 1100 mA Output Usb Socket A Type	Black	PC	12
P08 02 02	2	5v 2400 mA Output Usb Socket A+A	Black	PC	6
P18 02 03	2	20w-pd Output Usb Socket A+C Type	White	PC	6
P18 02 02	2	20w-pd Output Usb Socket A+C Type	Black	PC	6
P28 01 03	1	20w-pd Output Usb Socket C Type	White	PC	12
P28 01 02	1	20w-pd Output Usb Socket C Type	Black	PC	12
P28 02 03	2	5v 3000 mA Output Usb Socket C	White	PC	6
P28 02 02	2	5v 3000 mA Output Usb Socket C	Black	PC	6



HDMI Sockets

Code	Module	Description	Color	Raw Materail	Pack
P73 01 03	1	1 Module End Cape HDMI Socket	White	PC	1
P73 01 02	1	1 Module End Cape HDMI Socket	Black	PC	1
P73 02 03	2	2 Module End Cape HDMI Socket	White	PC	1
P73 02 02	2	2 Module End Cape HDMI Socket	Black	PC	1
P74 01 03	1	1 Module End Cape HDMI Socket	White	PC	1
P74 01 02	1	1 Module End Cape HDMI Socket	Black	PC	1
P74 02 03	2	2 Module End Cape HDMI Socket	White	PC	1
P74 02 02	2	2 Module End Cape HDMI Socket	Black	PC	1



Gap Cover

Code	Module	Product	Color	Raw Materail	Pack
P07 01 03	1	Gap Cover	White	ABS	24
P07 02 03	2	Gap Cover	White	ABS	12
P07 01 02	1	Gap Cover	Black	ABS	24
P07 02 02	2	Gap Cover	Black	ABS	12



SOCKETS



Sockets (Screw Connection)

Code	Module	Description	Color	Raw Materail	Pack
P06 02 03	2	Earth Socket 2 Module	White	PC	10
P06 02 02	2	Earth Socket 2 Module	Black	PC	10
P26 02 08	2	UPS Socket 2 Module	Red	PC	10



Sockets (Direct Cable Connection)

Code	Module	Description	Color	Raw Materail	Pack
P16 02 03	2	Earth Socket 2 Module	White	PC	10
P16 02 02	2	Earth Socket 2 Module	Black	PC	10
P27 02 08	2	UPS Socket 2 Module	Red	PC	10

Earth Universal Sockets and English Type Sockets

Code	Module	Description	Color	Raw Materail	Pack
P20 02 03	2	English Type Socket	White	PC	10
P20 02 02	2	English Type Socket	Black	PC	10
P25 02 03	2	Universal Socket	White	PC	10
P25 02 02	2	Universal Socket	Black	PC	10



Earth Universal Sockets and English Type Sockets

Code	Module	Description	Color	Raw Materail	Pack
P16 04 03	4	Earth Socket	White	PC	6
P16 04 03	6	Earth Socket	White	PC	4
P16 04 02	4	Earth Socket	Black	PC	6
P16 06 02	6	Earth Socket	Black	PC	4
P27 04 06	4	French Type UPS Socket	Red	PC	6
P27 06 08	6	French Type UPS Socket	Red	PC	4



SOCKETS



Data Sockets

Code	Module	Product	Color	Raw Materail	Pack
P13 01 03	1	CAT6 UTP	White	ABS	20
P23 01 03	1	CAT6 FTP	White	ABS	20
P33 01 03	1	CAT6A SFTP	White	ABS	20
P43 01 03	1	CAT5 UTP	White	ABS	20



faceplate

Code	Module	Product	Color	Raw Materail	Pack
P63 01 03	1	1 Module Faceplate	White	ABS	24
P63 02 03	2	2 Module Faceplate	White	ABS	12
P64 01 03	1	1 Module Faceplate	White	ABS	24
P64 02 03	2	2 Module Faceplate	White	ABS	12
P64 01 02	1	1 Module Faceplate	Black	ABS	24
P64 02 02	2	2 Module Faceplate	Black	ABS	12



Keystone Jack

Code	Module	Product	Color	Raw Materail	Pack
P53 01 02	1	CAT6 Keystone Jack	Black	ABS	100
P53 01 03	1	CAT6 Keystone Jack	White	ABS	100
P54 01 02	1	CAT3 Keystone Jack	Black	ABS	100
P54 01 03	1	CAT3 Keystone Jack	White	ABS	100

CPElegans Aluminium Duct Series

According to the size and accessories, color options are available in our stocks.

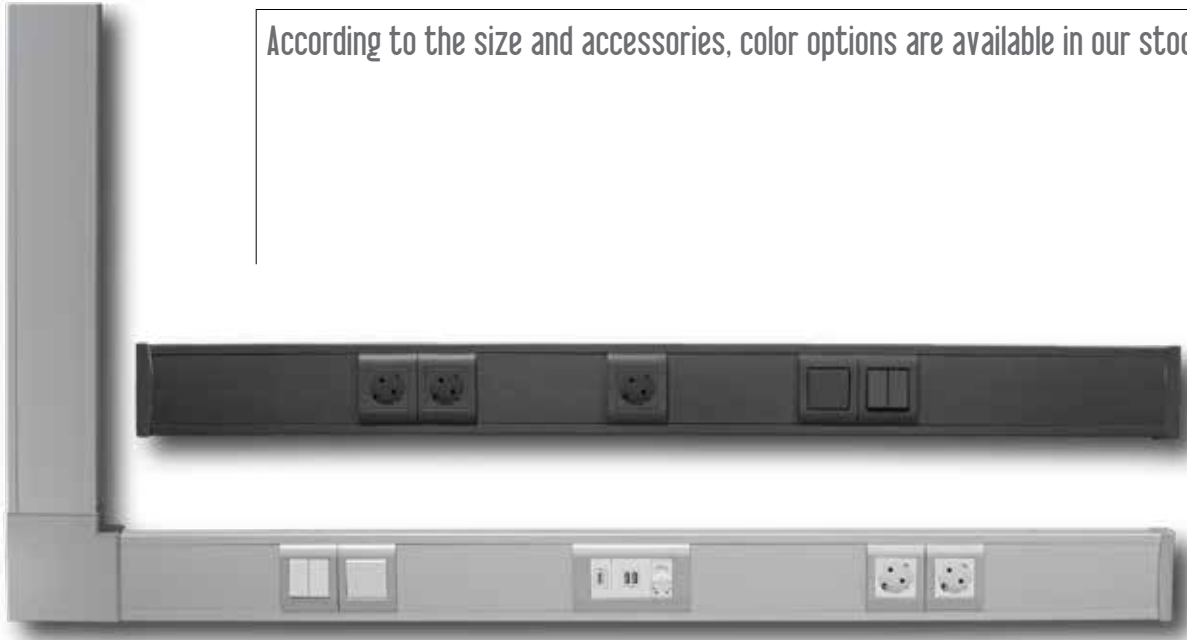

CPElegance Aluminium Duct Series

Code	Description	Colour	Raw Material	Unit
P11 01 01	50x100	Grey	Aluminum	Meter
P12 01 01	50x100 Internal Angle	Grey	Aluminum	Piece
P12 02 01	50x100 External Angle	Grey	Aluminum	Piece
P12 03 01	50x100 Flat Angle	Grey	Aluminum	Piece
P12 04 01	50x100 T Corner Angle	Grey	Aluminum	Piece
P12 05 01	50x100 Additional Corner	Grey	Aluminum	Piece
P12 06 01	50x100 2 Modular Frame	Grey	Aluminum	Piece
P12 07 01	50x100 4 Modular Frame	Grey	Aluminum	Piece
P12 08 01	50x100 6 Modular Frame	Grey	Aluminum	Piece
P12 09 01	50x100 End Cap	Grey	Aluminum	Piece
P14 01 01	Aluminium Duct Leg Connection Part	Grey	Aluminum	Piece



Internal Angle Piece



External Angle Piece



End Cap



Additional Piece



Flat Angle



Aluminium Duct Leg Connection Part



T Corner Angle

For sizes up to 3 meters

CPElegance Aluminium Duct Series

Code	Description	Colour	Raw Material	Unit
P11 01 04	50x100	Anthracite	Aluminum	Meter
P12 01 04	50x100 Internal Angle	Anthracite	Aluminum	Piece
P12 02 04	50x100 External Angle	Anthracite	Aluminum	Piece
P12 03 04	50x100 Flat Angle	Anthracite	Aluminum	Piece
P12 04 04	50x100 T Corner Angle	Anthracite	Aluminum	Piece
P12 05 04	50x100 Additional Corner	Anthracite	Aluminum	Piece
P12 06 04	50x100 2 Modular Frame	Anthracite	Aluminum	Piece
P12 07 04	50x100 4 Modular Frame	Anthracite	Aluminum	Piece
P12 08 04	50x100 6 Modular Frame	Anthracite	Aluminum	Piece
P12 09 04	50x100 End Cap	Anthracite	Aluminum	Piece
P14 01 04	Aluminium Duct Leg Connection Part	Anthracite	Aluminum	Piece



CP LIGHTING PRODUCT RANGE

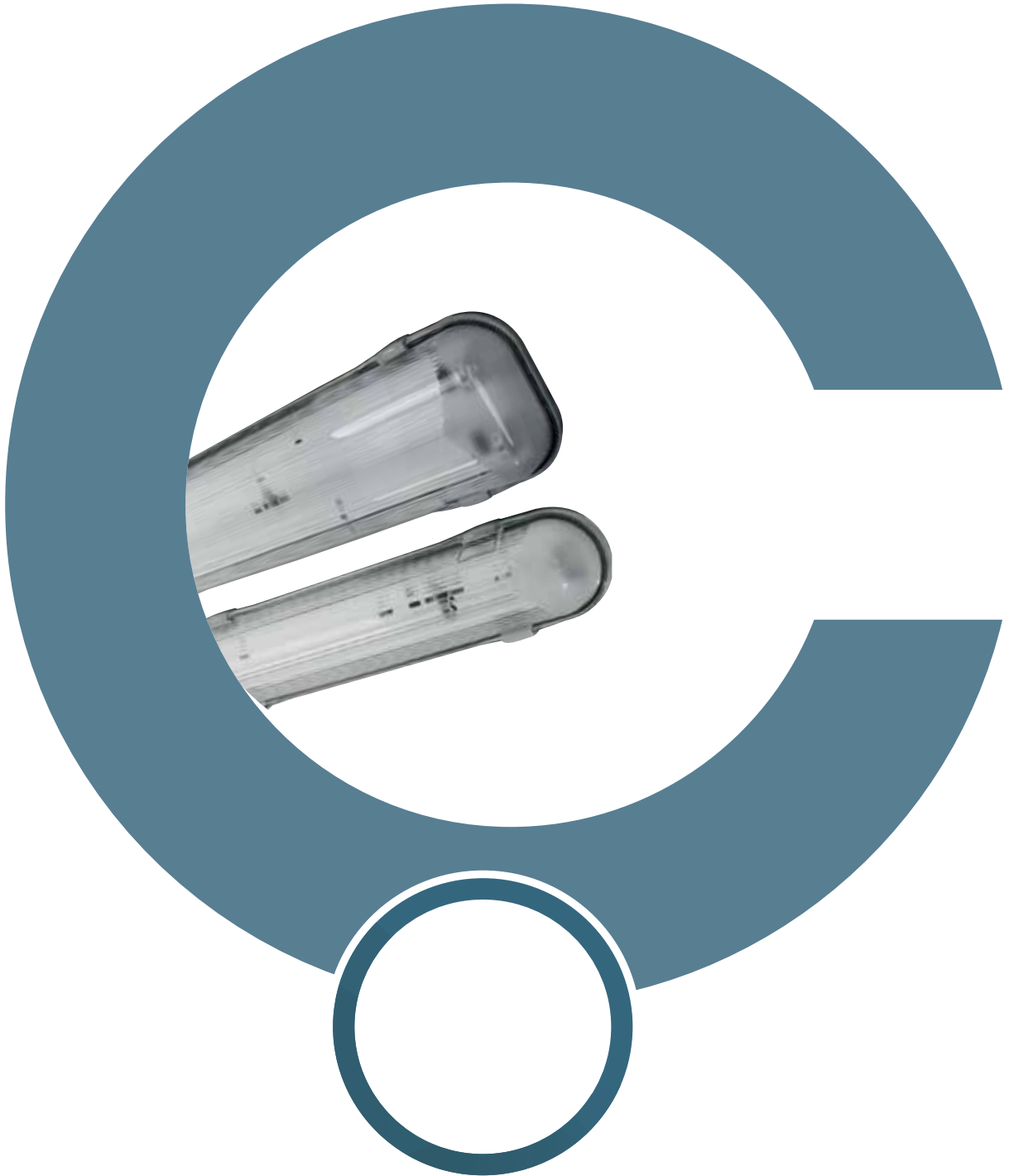

WATERPROOF LIGHTING FIXTURE



Technical Characteristic

- Designed by For Surface Mounting Application in Industrial and Commercial Environments
- ABS Body and Polycarbonate Cover With Plastic Clips
- Bright and Economical
- High - Impact Strength IK08
- Flame-Retardant UL95 HB
- Conform to European IEC Standards EN606170-1
- Corrosion-Free
- Easy to Use and Install
- CE Mark
- Weather-Proof IP65 TUV/PSB Certified



With Plastic Clips For T8 Fluorescent Lighting (With OSRAM/PHILIPS Electronic Ballast)

Code	Dimension	Voltage	Lamp Holder	Ballast	Pack
CA 58001	1x18	220V-240V AC	G13	Electronic	15
CA 58002	2x18	220V-240V AC	G13	Electronic	10
CA 58003	1x36	220V-240V AC	G13	Electronic	8
CA 58004	2x36	220V-240V AC	G13	Electronic	6
CA 58005	1x58	220V-240V AC	G13	Electronic	9
CA 58006	2x58	220V-240V AC	G13	Electronic	6



With Plastic Clips For T8 Emergency Kit (With OSRAM Ballast)

Code	Dimension	Voltage	Lamp Holder	Ballast	Emergency Option	Pack
CA 58201	1x18	220V-240V AC	G13	Electronic	90 minute	15
CA 58202	1x18	220V-240V AC	G13	Electronic	180 minute	15
CA 58203	2x18	220V-240V AC	G13	Electronic	90 minute	10
CA 58204	2x18	220V-240V AC	G13	Electronic	180 minute	10
CA 58205	1x36	220V-240V AC	G13	Electronic	90 minute	8
CA 58206	1x36	220V-240V AC	G13	Electronic	180 minute	8
CA 58207	2x36	220V-240V AC	G13	Electronic	90 minute	6
CA 58208	2x36	220V-240V AC	G13	Electronic	180 minute	6
CA 58209	1x58	220V-240V AC	G13	Electronic	90 minute	9
CA 58210	1x58	220V-240V AC	G13	Electronic	180 minute	9
CA 58211	2x58	220V-240V AC	G13	Electronic	90 minute	6
CA 58212	2x58	220V-240V AC	G13	Electronic	180 minute	6

* Included emergency kit



WATERPROOF LIGHTING FIXTURE



Technical Characteristic

- Designed by For Surface Mounting Application in Industrial and Commercial Environments
- ABS Body and Polycarbonate Cover With Plastic Clips
- Bright and Economical
- High - Impact Strength IK08
- Flame-Retardant UL95 HB
- Conform to European IEC Standards EN606170-1
- Corrosion-Free
- Easy to Use and Install
- CE Mark
- Weather-Proof IP65 TUV/PSB Certified



With Plastic Clips For T8 Fluorescent Lighting (With Eco Ballast)

Code	Dimension	Voltage	Lamp Holder	Ballast	Pack
CA 55017	1x18	220V-240V AC	G13	Electronic	15
CA 55018	2x18	220V-240V AC	G13	Electronic	10
CA 55019	1x36	220V-240V AC	G13	Electronic	8
CA 55020	2x36	220V-240V AC	G13	Electronic	6
CA 55021	1x58	220V-240V AC	G13	Electronic	9
CA 55022	2x58	220V-240V AC	G13	Electronic	6



With Plastic Clips For T8 Emergency Kit (With Eco Ballast)

Code	Dimension	Voltage	Lamp Holder	Ballast	Emergency Option	Pack
CA 55317	1x18	220V-240V AC	G13	Electronic	90 minute	15
CA 55417	1x18	220V-240V AC	G13	Electronic	180 minute	15
CA 55318	2x18	220V-240V AC	G13	Electronic	90 minute	10
CA 55418	2x18	220V-240V AC	G13	Electronic	180 minute	10
CA 55319	1x36	220V-240V AC	G13	Electronic	90 minute	8
CA 55419	1x36	220V-240V AC	G13	Electronic	180 minute	8
CA 55320	2x36	220V-240V AC	G13	Electronic	90 minute	6
CA 55420	2x36	220V-240V AC	G13	Electronic	180 minute	6
CA 55321	1x58	220V-240V AC	G13	Electronic	90 minute	9
CA 55421	1x58	220V-240V AC	G13	Electronic	180 minute	9
CA 55322	2x58	220V-240V AC	G13	Electronic	90 minute	6
CA 55422	2x58	220V-240V AC	G13	Electronic	180 minute	6

* Included emergency kit

WATERPROOF LIGHTING FIXTURE



Technical Characteristic

- Designed by For Surface Mounting Application in Industrial and Commercial Environments
- ABS Body and Polycarbonate Cover With Plastic Clips
- Bright and Economical
- High - Impact Strength IK08
- Flame-Retardant UL95 HB
- Conform to European IEC Standards EN606170-1
- Corrosion-Free
- Easy to Use and Install
- CE Mark
- Weather-Proof IP65 TUV/PSB Certified



With Plastic Clips For Led Tube

Code	Dimension	Voltage	Lamp Holder	Ballast	Emergency Option	Pack
CA 58021	1x660 mm.	220V-240V AC	G13	No	No	15
CA 58022	2x660 mm.	220V-240V AC	G13	No	Yes	10
CA 58023	1x1268 mm.	220V-240V AC	G13	No	Yes	8
CA 58024	2x1268 mm.	220V-240V AC	G13	No	Yes	6
CA 58025	1x1562 mm.	220V-240V AC	G13	No	Yes	9
CA 58026	2x1562 mm.	220V-240V AC	G13	No	Yes	6



With Plastic Clips Led Strips - Soft Cover

Code	Dimension	Voltage	Watt	Lumen	Pack
CA 59001	1x660 mm.	220V-240V	8.70 W	3000 K	15
CA 59002	1x660 mm.	220V-240V	8.70 W	4000 K	15
CA 59003	1x660 mm.	220V-240V	8.70 W	6500 K	15
CA 59004	1x1268 mm.	220V-240V	17.50 W	3000 K	8
CA 59005	1x1268 mm.	220V-240V	17.50 W	4000 K	8
CA 59006	1x1268 mm.	220V-240V	17.50 W	6500 K	8
CA 59007	1x1562 mm.	220V-240V	26.30 W	3000 K	9
CA 59008	1x1562 mm.	220V-240V	26.30 W	4000 K	9
CA 59009	1x1562 mm.	220V-240V	26.30 W	6500 K	9



With Plastic Clips Led Strips - Soft Cover

Code	Dimension	Voltage	Watt	Lumen	Pack
CA 59010	2x660 mm.	220V-240V	15.35 W	3000 K	10
CA 59011	2x660 mm.	220V-240V	15.35 W	4000 K	10
CA 59012	2x660 mm.	220V-240V	15.35 W	6500 K	10
CA 59013	2x1268 mm.	220V-240V	30.70 W	3000 K	6
CA 59014	2x1268 mm.	220V-240V	30.70 W	4000 K	6
CA 59015	2x1268 mm.	220V-240V	30.70 W	6500 K	6
CA 59016	2x1562 mm.	220V-240V	46.00 W	3000 K	6
CA 59017	2x1562 mm.	220V-240V	46.00 W	4000 K	6
CA 59018	2x1562 mm.	220V-240V	46.00 W	6500 K	6

WATERPROOF LIGHTING FIXTURE



Technical Characteristic

- Designed by For Surface Mounting Application in Industrial and Commercial Environments
- ABS Body and Polycarbonate Cover With Stainless Steel Clips
- Bright and Economical
- High - Impact Strength IK08
- Flame-Retardant UL95 HB
- Conform to European IEC Standards EN606170-1
- Corrosion-Free
- Easy to Use and Install
- CE Mark
- Weather-Proof IP65 TUV/PSB Certified



With Stainless Steel Clips For T8 Fluorescent Lighting (With OSRAM/PHILIPS Electronic Balast)

Code	Dimension	Voltage	Lamp Holder	Ballast	Emergency Option	Pack
CA 58001M	1x18	220V-240V AC	G13	Yes	No	15
CA 58002M	2x18	220V-240V AC	G13	Yes	Yes	10
CA 58003M	1x36	220V-240V AC	G13	Yes	Yes	8
CA 58004M	2x36	220V-240V AC	G13	Yes	Yes	6
CA 58005M	1x58	220V-240V AC	G13	Yes	Yes	9
CA 58006M	2x58	220V-240V AC	G13	Yes	Yes	6



With Stainless Steel Clips For T8 Fluorescent Lighting (With Eco Balast)

Code	Dimension	Voltage	Lamp Holder	Ballast	Emergency Option	Pack
CA 55017M	1x18	220V-240V AC	G13	Yes	No	15
CA 55018M	2x18	220V-240V AC	G13	Yes	Yes	10
CA 55019M	1x36	220V-240V AC	G13	Yes	Yes	8
CA 55020M	2x36	220V-240V AC	G13	Yes	Yes	6
CA 55021M	1x58	220V-240V AC	G13	Yes	Yes	9
CA 55022M	2x58	220V-240V AC	G13	Yes	Yes	6

WATERPROOF LIGHTING FIXTURE



Technical Characteristic

- Designed by For Surface Mounting Application in Industrial and Commercial Environments
- ABS Body and Polycarbonate Cover With Stainless Steel Clips
- Bright and Economical
- High - Impact Strength IK08
- Flame-Retardant UL95 HB
- Conform to European IEC Standards EN606170-1
- Corrosion-Free
- Easy to Use and Install
- CE Mark
- Weather-Proof IP65 TUV/PSB Certified



With Stainless Steel Clips For Led Tube

Code	Dimension	Voltage	Lamp Holder	Ballast	Emergency Option	Pack
CA 58021M	1x660 mm.	220V-240V AC	G13	No	No	15
CA 58022M	2x660 mm.	220V-240V AC	G13	No	Yes	10
CA 58023M	1x1268 mm.	220V-240V AC	G13	No	Yes	8
CA 58024M	2x1268 mm.	220V-240V AC	G13	No	Yes	6
CA 58025M	1x1562 mm.	220V-240V AC	G13	No	Yes	9
CA 58026M	2x1562 mm.	220V-240V AC	G13	No	Yes	6



With Stainless Steel Clips Led Strips - Soft Cover

Code	Dimension	Voltage	Watt	Lumen	Pack
CA 59001M	1x660 mm.	220V-240V	8.70 W	3000 K	15
CA 59002M	1x660 mm.	220V-240V	8.70 W	4000 K	15
CA 59003M	1x660 mm.	220V-240V	8.70 W	6500 K	15
CA 59004M	1x1268 mm.	220V-240V	17.50 W	3000 K	8
CA 59005M	1x1268 mm.	220V-240V	17.50 W	4000 K	8
CA 59006M	1x1268 mm.	220V-240V	17.50 W	6500 K	8
CA 59007M	1x1562 mm.	220V-240V	26.30 W	3000 K	9
CA 59008M	1x1562 mm.	220V-240V	26.30 W	4000 K	9
CA 59009M	1x1562 mm.	220V-240V	26.30 W	6500 K	9



With Stainless Steel Clips Led Strips - Soft Cover

Code	Dimension	Voltage	Watt	Lumen	Pack
CA 59010M	2x660 mm.	220V-240V	15.35 W	3000 K	15
CA 59011M	2x660 mm.	220V-240V	15.35 W	4000 K	15
CA 59012M	2x660 mm.	220V-240V	15.35 W	6500 K	15
CA 59013M	2x1268 mm.	220V-240V	30.70 W	3000 K	8
CA 59014M	2x1268 mm.	220V-240V	30.70 W	4000 K	8
CA 59015M	2x1268 mm.	220V-240V	30.70 W	6500 K	8
CA 59016M	2x1562 mm.	220V-240V	46.00 W	3000 K	9
CA 59017M	2x1562 mm.	220V-240V	46.00 W	4000 K	9
CA 59018M	2x1562 mm.	220V-240V	46.00 W	6500 K	9



CP STABILIZER PRODUCT RANGE



VOLTAGE STABILIZER

Technical Characteristic

- Input Voltage : 175/265V
- Output Voltage : 220V

Single-Phase Micro Processor Electronic

Code	Protection unit	Power (K.V.A.)	Characteristic of Product
S11 A1Y 00	S11 A1KY 00	1	Aluminium Wired
S11 A1Y 01	S11 A1KY 01	2	Aluminium Wired
S11 A1Y 02	S11 A1KY 02	3.5	Aluminium Wired
S11 A1Y 03	S11 A1KY 03	5	Aluminium Wired
S11 A1Y 04	S11 A1KY 04	7.5	Aluminium Wired
S11 A1Y 05	S11 A1KY 05	10	Aluminium Wired
S11 A1Y 06	S11 A1KY 06	15	Aluminium Wired
S11 A1Y 07	S11 A1KY 07	20	Aluminium Wired
S11 A1Y 08	S11 A1KY 08	25	Aluminium Wired
S11 A1Y 09	S11 A1KY 09	30	Aluminium Wired
S11 A1Y 10	S11 A1KY 10	40	Aluminium Wired
S11 A1Y 11	S11 A1KY 11	50	Aluminium Wired



Technical Characteristic

- Input Voltage : 150/250V
- Output Voltage : 220V

Single-Phase Micro Processor Electronic

Code	Protection unit	Power (K.V.A.)	Characteristic of Product
S11 A1N 00	S11 A1KN 00	1	Aluminium Wired
S11 A1N 01	S11 A1KN 01	2	Aluminium Wired
S11 A1N 02	S11 A1KN 02	3.5	Aluminium Wired
S11 A1N 03	S11 A1KN 03	5	Aluminium Wired
S11 A1N 04	S11 A1KN 04	7.5	Aluminium Wired
S11 A1N 05	S11 A1KN 05	10	Aluminium Wired
S11 A1N 06	S11 A1KN 06	15	Aluminium Wired
S11 A1N 07	S11 A1KN 07	20	Aluminium Wired
S11 A1N 08	S11 A1KN 08	25	Aluminium Wired
S11 A1N 09	S11 A1KN 09	30	Aluminium Wired
S11 A1N 10	S11 A1KN 10	40	Aluminium Wired
S11 A1N 11	S11 A1KN 11	50	Aluminium Wired

Technical Characteristic

- Input Voltage : 300/460V
- Output Voltage : 380V

Three-Phase Micro Processor Electronic

Code	Protection unit	Power (K.V.A.)	Characteristic of Product
S11 A3Y 01	S11 A3KY 01	6	Aluminium Wired
S11 A3Y 02	S11 A3KY 02	10.5	Aluminium Wired
S11 A3Y 03	S11 A3KY 03	15	Aluminium Wired
S11 A3Y 04	S11 A3KY 04	22.5	Aluminium Wired
S11 A3Y 05	S11 A3KY 05	30	Aluminium Wired
S11 A3Y 06	S11 A3KY 06	45	Aluminium Wired
S11 A3Y 07	S11 A3KY 07	60	Aluminium Wired
S11 A3Y 08	S11 A3KY 08	75	Aluminium Wired
S11 A3Y 09	S11 A3KY 09	100	Aluminium Wired
S11 A3Y 10	S11 A3KY 10	120	Aluminium Wired
S11 A3Y 11	S11 A3KY 11	150	Aluminium Wired
S11 A3Y 12	S11 A3KY 12	200	Aluminium Wired
S11 A3Y 13	S11 A3KY 13	250	Aluminium Wired
S11 A3Y 14	S11 A3KY 14	300	Aluminium Wired
S11 A3Y 15	S11 A3KY 15	400	Aluminium Wired
S11 A3Y 16	S11 A3KY 16	500	Aluminium Wired
S11 A3Y 17	S11 A3KY 17	600	Aluminium Wired
S11 A3Y 18	S11 A3KY 18	800	Aluminium Wired
S11 A3Y 19	S11 A3KY 19	1000	Aluminium Wired
S11 A3Y 20	S11 A3KY 20	1250	Aluminium Wired
S11 A3Y 21	S11 A3KY 21	1600	Aluminium Wired
S11 A3Y 22	S11 A3KY 22	2000	Aluminium Wired
S11 A3Y 23	S11 A3KY 23	2500	Aluminium Wired
S11 A3Y 24	S11 A3KY 24	3250	Aluminium Wired



Technical Characteristic

- Input Voltage : 260/450V
- Output Voltage : 380V

Three-Phase Micro Processor Electronic

Code	Protection unit	Power (K.V.A.)	Characteristic of Product
S11 A3N 26	S11 A3KN 26	6	Aluminium Wired
S11 A3N 27	S11 A3KN 27	10.5	Aluminium Wired
S11 A3N 28	S11 A3KN 28	15	Aluminium Wired
S11 A3N 29	S11 A3KN 29	22.5	Aluminium Wired
S11 A3N 30	S11 A3KN 30	30	Aluminium Wired
S11 A3N 31	S11 A3KN 31	45	Aluminium Wired
S11 A3N 32	S11 A3KN 32	60	Aluminium Wired
S11 A3N 33	S11 A3KN 33	75	Aluminium Wired
S11 A3N 34	S11 A3KN 34	100	Aluminium Wired
S11 A3N 35	S11 A3KN 35	120	Aluminium Wired
S11 A3N 36	S11 A3KN 36	150	Aluminium Wired
S11 A3N 37	S11 A3KN 37	200	Aluminium Wired
S11 A3N 38	S11 A3KN 38	250	Aluminium Wired
S11 A3N 39	S11 A3KN 39	300	Aluminium Wired
S11 A3N 40	S11 A3KN 40	400	Aluminium Wired
S11 A3N 41	S11 A3KN 41	500	Aluminium Wired
S11 A3N 42	S11 A3KN 42	600	Aluminium Wired
S11 A3N 43	S11 A3KN 43	800	Aluminium Wired
S11 A3N 44	S11 A3KN 44	1000	Aluminium Wired
S11 A3N 45	S11 A3KN 45	1250	Aluminium Wired
S11 A3N 46	S11 A3KN 46	1600	Aluminium Wired
S11 A3N 47	S11 A3KN 47	2000	Aluminium Wired
S11 A3N 48	S11 A3KN 48	2500	Aluminium Wired
S11 A3N 49	S11 A3KN 49	3250	Aluminium Wired

VOLTAGE STABILIZER

Technical Characteristic

- Input Voltage : 175/265V
- Output Voltage : 220V

Single-Phase Micro Processor Electronic

Code	Protection unit	Power (K.V.A.)	Characteristic of Product
S11 C1Y 00	S11 C1KY 00	1	Copper Wired
S11 C1Y 01	S11 C1KY 01	2	Copper Wired
S11 C1Y 02	S11 C1KY 02	3.5	Copper Wired
S11 C1Y 03	S11 C1KY 03	5	Copper Wired
S11 C1Y 04	S11 C1KY 04	7.5	Copper Wired
S11 C1Y 05	S11 C1KY 05	10	Copper Wired
S11 C1Y 06	S11 C1KY 06	15	Copper Wired
S11 C1Y 07	S11 C1KY 07	20	Copper Wired
S11 C1Y 08	S11 C1KY 08	25	Copper Wired
S11 C1Y 09	S11 C1KY 09	30	Copper Wired
S11 C1Y 10	S11 C1KY 10	40	Copper Wired
S11 C1Y 11	S11 C1KY 11	50	Copper Wired



Technical Characteristic

- Input Voltage : 150/250V
- Output Voltage : 220V

Single-Phase Micro Processor Electronic

Code	Protection unit	Power (K.V.A.)	Characteristic of Product
S11 C1N 00	S11 C1KN 00	1	Copper Wired
S11 C1N 01	S11 C1KN 01	2	Copper Wired
S11 C1N 02	S11 C1KN 02	3.5	Copper Wired
S11 C1N 03	S11 C1KN 03	5	Copper Wired
S11 C1N 04	S11 C1KN 04	7.5	Copper Wired
S11 C1N 05	S11 C1KN 05	10	Copper Wired
S11 C1N 06	S11 C1KN 06	15	Copper Wired
S11 C1N 07	S11 C1KN 07	20	Copper Wired
S11 C1N 08	S11 C1KN 08	25	Copper Wired
S11 C1N 09	S11 C1KN 09	30	Copper Wired
S11 C1N 10	S11 C1KN 10	40	Copper Wired
S11 C1N 11	S11 C1KN 11	50	Copper Wired

Technical Characteristic

- Input Voltage : 300/460V
- Output Voltage : 380V

Three-Phase Micro Processor Electronic

Code	Protection unit	Power (K.V.A.)	Characteristic of Product
S11 C3Y 01	S11 C3KY 01	6	Copper Wired
S11 C3Y 02	S11 C3KY 02	10.5	Copper Wired
S11 C3Y 03	S11 C3KY 03	15	Copper Wired
S11 C3Y 04	S11 C3KY 04	22.5	Copper Wired
S11 C3Y 05	S11 C3KY 05	30	Copper Wired
S11 C3Y 06	S11 C3KY 06	45	Copper Wired
S11 C3Y 07	S11 C3KY 07	60	Copper Wired
S11 C3Y 08	S11 C3KY 08	75	Copper Wired
S11 C3Y 09	S11 C3KY 09	100	Copper Wired
S11 C3Y 10	S11 C3KY 10	120	Copper Wired
S11 C3Y 11	S11 C3KY 11	150	Copper Wired
S11 C3Y 12	S11 C3KY 12	200	Copper Wired
S11 C3Y 13	S11 C3KY 13	250	Copper Wired
S11 C3Y 14	S11 C3KY 14	300	Copper Wired
S11 C3Y 15	S11 C3KY 15	400	Copper Wired
S11 C3Y 16	S11 C3KY 16	500	Copper Wired
S11 C3Y 17	S11 C3KY 17	600	Copper Wired
S11 C3Y 18	S11 C3KY 18	800	Copper Wired
S11 C3Y 19	S11 C3KY 19	1000	Copper Wired
S11 C3Y 20	S11 C3KY 20	1250	Copper Wired
S11 C3Y 21	S11 C3KY 21	1600	Copper Wired
S11 C3Y 22	S11 C3KY 22	2000	Copper Wired
S11 C3Y 23	S11 C3KY 23	2500	Copper Wired
S11 C3Y 24	S11 C3KY 24	3250	Copper Wired



Technical Characteristic

- Input Voltage : 260/450V
- Output Voltage : 380V

Three-Phase Micro Processor Electronic

Code	Protection unit	Power (K.V.A.)	Characteristic of Product
S11 C3N 26	S11 C3KN 26	6	Copper Wired
S11 C3N 27	S11 C3KN 27	10.5	Copper Wired
S11 C3N 28	S11 C3KN 28	15	Copper Wired
S11 C3N 29	S11 C3KN 29	22.5	Copper Wired
S11 C3N 30	S11 C3KN 30	30	Copper Wired
S11 C3N 31	S11 C3KN 31	45	Copper Wired
S11 C3N 32	S11 C3KN 32	60	Copper Wired
S11 C3N 33	S11 C3KN 33	75	Copper Wired
S11 C3N 34	S11 C3KN 34	100	Copper Wired
S11 C3N 35	S11 C3KN 35	120	Copper Wired
S11 C3N 36	S11 C3KN 36	150	Copper Wired
S11 C3N 37	S11 C3KN 37	200	Copper Wired
S11 C3N 38	S11 C3KN 38	250	Copper Wired
S11 C3N 39	S11 C3KN 39	300	Copper Wired
S11 C3N 40	S11 C3KN 40	400	Copper Wired
S11 C3N 41	S11 C3KN 41	500	Copper Wired
S11 C3N 42	S11 C3KN 42	600	Copper Wired
S11 C3N 43	S11 C3KN 43	800	Copper Wired
S11 C3N 44	S11 C3KN 44	1000	Copper Wired
S11 C3N 45	S11 C3KN 45	1250	Copper Wired
S11 C3N 46	S11 C3KN 46	1600	Copper Wired
S11 C3N 47	S11 C3KN 47	2000	Copper Wired
S11 C3N 48	S11 C3KN 48	2500	Copper Wired
S11 C3N 49	S11 C3KN 49	3250	Copper Wired

POOL TRANSFORMER

Pool Transformer

Code	Characteristic of Product
S23 C00 00	220/12V 50VA Copper Wired - Polyester Body
S23 C00 01	220/12V 100VA Copper Wired - Polyester Body
S23 C00 02	220/12V 150VA Copper Wired - Polyester Body
S23 C00 03	220/12V 300VA Copper Wired - Polyester Body
S23 C00 04	220/12V 400VA Copper Wired - Polyester Body
S23 C00 05	220/12V 600VA Copper Wired - Polyester Body



Pool Transformer

Code	Characteristic of Product
S23 A00 00	220/12V 300VA Aluminium Wired - Polyester Body
S23 A00 01	220/12V 400VA Aluminium Wired - Polyester Body
S23 A00 02	220/12V 600VA Aluminium Wired - Polyester Body



VOLTAGE STABILIZER & TRANSFORMER



Stabilizer - With Metal Body

Code	Power (VA.)	Characteristic of Product
S14 1M0 00	500 VA	Voltage 130/270/220 Aluminium Wired
S14 1M0 01	1000 VA	Voltage 130/270/220 Aluminium Wired
S14 1M0 02	1500 VA	Voltage 130/270/220 Aluminium Wired
S14 1M0 03	1500K VA	Voltage 130/270/220 with condensator Al. Wired



Stabilizer - With Plastic Body

Code	Power (VA.)	Characteristic of Product
S14 1P0 00	500 VA	Voltage 130/270/220 Aluminium Wired
S14 1P0 01	1000 VA	Voltage 130/270/220 Aluminium Wired



Transformer - New Model 220/12 - 220/24

Code	Power (VA.)
S21 C12K 00	30 VA
S21 C12K 01	50 VA
S21 C12K 02	75 VA
S21 C12K 03	100 VA
S21 C12K 04	150 VA
S21 C12K 05	200 VA
S21 C12K 06	250 VA

Aluminium Wired Transformer



Code	Code	Code	Code	Power (VA.)
220/24 V	380/24 V	220/12 V	380/220 V	
S21 A12 00	S21 A13 00	S21 A11 00	S21 A14 00	30 VA
S21 A12 01	S21 A13 01	S21 A11 01	S21 A14 01	50 VA
S21 A12 02	S21 A13 02	S21 A11 02	S21 A14 02	100 VA
S21 A12 03	S21 A13 03	S21 A11 03	S21 A14 03	150 VA
S21 A12 04	S21 A13 04	S21 A11 04	S21 A14 04	200 VA
S21 A12 05	S21 A13 05	S21 A11 05	S21 A14 05	250 VA
S21 A12 06	S21 A13 06	S21 A11 06	S21 A14 06	300 VA
S21 A12 07	S21 A13 07	S21 A11 07	S21 A14 07	400 VA
S21 A12 08	S21 A13 08	S21 A11 08	S21 A14 08	500 VA
S21 A12 09	S21 A13 09	S21 A11 09	S21 A14 09	600 VA
S21 A12 10	S21 A13 10	S21 A11 10	S21 A14 10	750 VA
S21 A12 11	S21 A13 11	S21 A11 11	S21 A14 11	1000 VA
S21 A12 12	S21 A13 12	S21 A11 12	S21 A14 12	1500 VA
S21 A12 13	S21 A13 13	S21 A11 13	S21 A14 13	2000 VA
S21 A12 14	S21 A13 14	S21 A11 14	S21 A14 14	2500 VA
S21 A12 15	S21 A13 15	S21 A11 15	S21 A14 15	3000 VA
S21 A12 16	S21 A13 16	S21 A11 16	S21 A14 16	4000 VA
S21 A12 17	S21 A13 17	S21 A11 17	S21 A14 17	5000 VA
S21 A12 18	S21 A13 18	S21 A11 18	S21 A14 18	6000 VA
S21 A12 19	S21 A13 19	S21 A11 19	S21 A14 19	7000 VA
S21 A12 20	S21 A13 20	S21 A11 20	S21 A14 20	8000 VA
S21 A12 21	S21 A13 21	S21 A11 21	S21 A14 21	10000 VA

Cooper Wired Transformer



Code	Code	Code	Code	Power (VA.)
220/24 V	380/24 V	220/12 V	380/220 V	
S21 C12 00	S21 C13 00	S21 C11 00	S21 C14 00	30 VA
S21 C12 01	S21 C13 01	S21 C11 01	S21 C14 01	50 VA
S21 C12 02	S21 C13 02	S21 C11 02	S21 C14 02	100 VA
S21 C12 03	S21 C13 03	S21 C11 03	S21 C14 03	150 VA
S21 C12 04	S21 C13 04	S21 C11 04	S21 C14 04	200 VA
S21 C12 05	S21 C13 05	S21 C11 05	S21 C14 05	250 VA
S21 C12 06	S21 C13 06	S21 C11 06	S21 C14 06	300 VA
S21 C12 07	S21 C13 07	S21 C11 07	S21 C14 07	400 VA
S21 C12 08	S21 C13 08	S21 C11 08	S21 C14 08	500 VA
S21 C12 09	S21 C13 09	S21 C11 09	S21 C14 09	600 VA
S21 C12 10	S21 C13 10	S21 C11 10	S21 C14 10	750 VA
S21 C12 11	S21 C13 11	S21 C11 11	S21 C14 11	1000 VA
S21 C12 12	S21 C13 12	S21 C11 12	S21 C14 12	1500 VA
S21 C12 13	S21 C13 13	S21 C11 13	S21 C14 13	2000 VA
S21 C12 14	S21 C13 14	S21 C11 14	S21 C14 14	2500 VA
S21 C12 15	S21 C13 15	S21 C11 15	S21 C14 15	3000 VA
S21 C12 16	S21 C13 16	S21 C11 16	S21 C14 16	4000 VA
S21 C12 17	S21 C13 17	S21 C11 17	S21 C14 17	5000 VA
S21 C12 18	S21 C13 18	S21 C11 18	S21 C14 18	6000 VA
S21 C12 19	S21 C13 19	S21 C11 19	S21 C14 19	7000 VA
S21 C12 20	S21 C13 20	S21 C11 20	S21 C14 20	8000 VA
S21 C12 21	S21 C13 21	S21 C11 21	S21 C14 21	10000 VA



Aluminium Wired Transformer

Code	Code	Power (V.A.)
380-220 V / 220-380 V It is produced in the desired voltage.		
S22 A30 00	S22-A30K-00	1000 VA
S22 A30 01	S22-A30K-01	1500 VA
S22 A30 02	S22-A30K-02	2000 VA
S22 A30 03	S22-A30K-03	3000 VA
S22 A30 04	S22-A30K-04	4000 VA
S22 A30 05	S22-A30K-05	5000 VA
S22 A30 06	S22-A30K-06	7500 VA
S22 A30 07	S22-A30K-07	10000 VA
S22 A30 08	S22-A30K-08	15000 VA
S22 A30 09	S22-A30K-09	20000 VA
S22 A30 10	S22-A30K-10	30000 VA
S22 A30 12	S22-A30K-11	40000 VA
S22 A30 13	S22-A30K-12	50000 VA
S22 A30 14	S22-A30K-13	70000 VA



Cooper Wired Transformer

Code	Code	Power (V.A.)
380-220 V / 220-380 V It is produced in the desired voltage.		
S22 C30 00	S22-C30K-00	1000 VA
S22 C30 01	S22-C30K-01	1500 VA
S22 C30 02	S22-C30K-02	2000 VA
S22 C30 03	S22-C30K-03	3000 VA
S22 C30 04	S22-C30K-04	4000 VA
S22 C30 05	S22-C30K-05	5000 VA
S22 C30 06	S22-C30K-06	7500 VA
S22 C30 07	S22-C30K-07	10000 VA
S22 C30 08	S22-C30K-08	15000 VA
S22 C30 09	S22-C30K-09	20000 VA
S22 C30 10	S22-C30K-10	30000 VA
S22 C30 12	S22-C30K-11	40000 VA
S22 C30 13	S22-C30K-12	50000 VA
S22 C30 14	S22-C30K-13	70000 VA

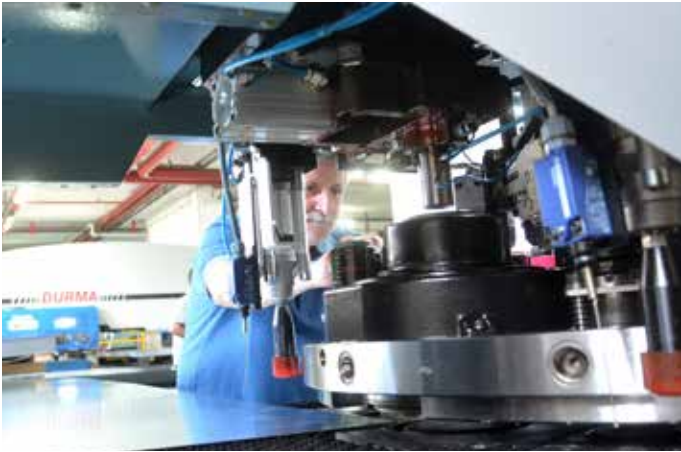

FOLLOW US ON SOCIAL MEDIA!



FOLLOW US!



: **cetinkayapano**



: **cetinkayapano**



: **cetinkayapano**



: **cetinkayapano**



: **CETINKAYAPANO**



: **www.cetinkayapano.com**



Over 100 countries around the world...



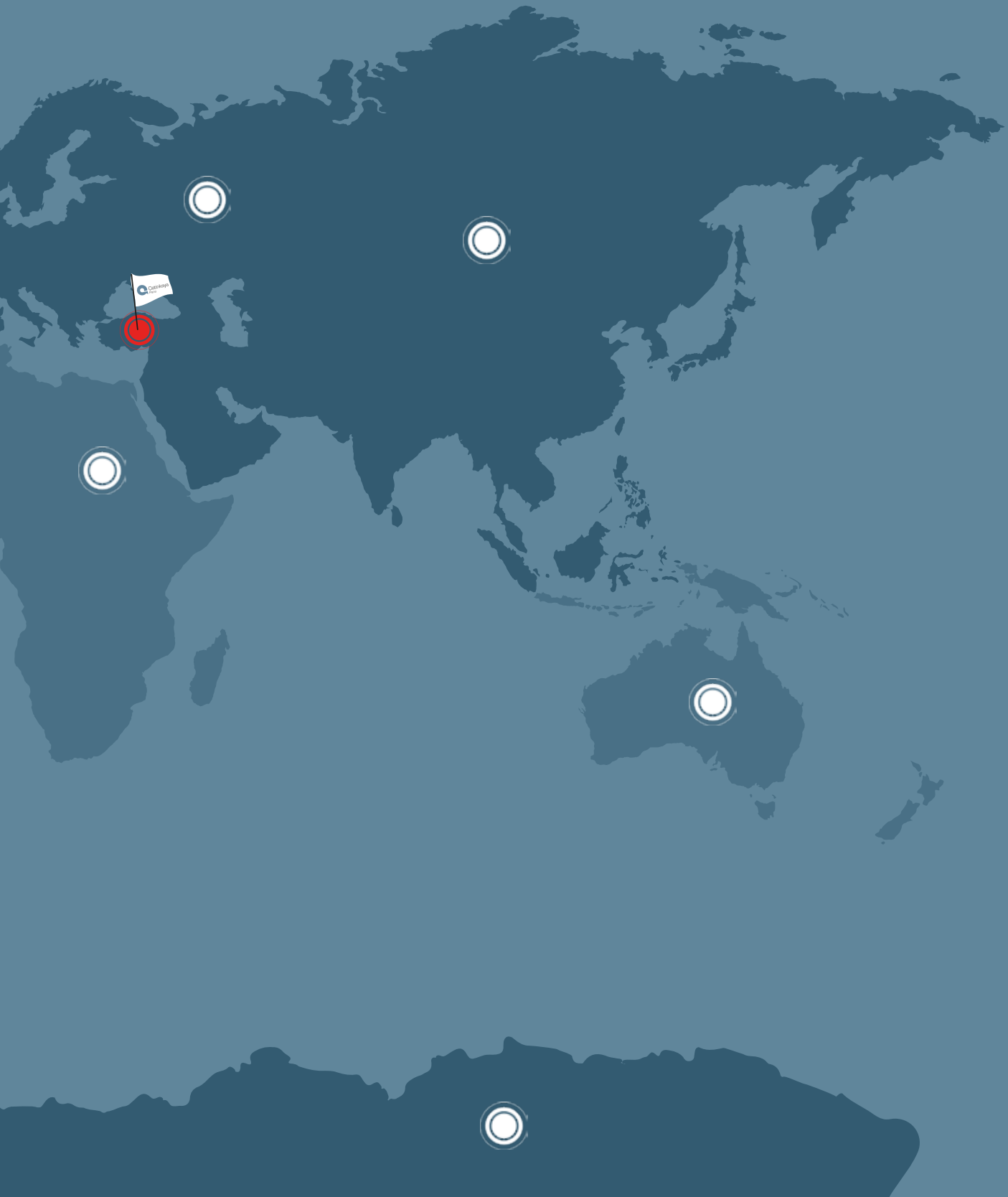



Cetinkaya
Pano

Cetinkaya Pano A.S.

International

Sales : Sair Ziya Pasa Caddesi Hidayet Han No. 45/6
34420 Karakoy - Istanbul / TURKEY

Phone : 00 90 212 255 04 69

Fax : 00 90 212 255 04 79

e-mail : exportsales@cetinkayapano.com

www.cetinkayapano.com