

## A SERİSİ MODÜLER DİKİLİ TİP MONTAJ PLAKALI PANOLAR

ÜRÜN KODU	E (mm)	B (mm)	D (mm)
ÇPA 5018040 MPT	500	1800	400
ÇPA 5018050 MPT	500	1800	500
ÇPA 5018060 MPT	500	1800	600
ÇPA 5020040 MPT	500	2000	400
ÇPA 5020050 MPT	500	2000	500
ÇPA 5020060 MPT	500	2000	600
ÇPA 6018040 MPT	600	1800	400
ÇPA 6018050 MPT	600	1800	500
ÇPA 6018060 MPT	600	1800	600
ÇPA 6020040 MPT	600	2000	400
ÇPA 6020050 MPT	600	2000	500
ÇPA 6020060 MPT	600	2000	600
ÇPA 7018040 MPT	700	1800	400
ÇPA 7018050 MPT	700	1800	500
ÇPA 7018060 MPT	700	1800	600
ÇPA 7020040 MPT	700	2000	400
ÇPA 7020050 MPT	700	2000	500
ÇPA 7020060 MPT	700	2000	600
ÇPA 8018040 MPT	800	1800	400
ÇPA 8018050 MPT	800	1800	500
ÇPA 8018060 MPT	800	1800	600
ÇPA 8020040 MPT	800	2000	400
ÇPA 8020050 MPT	800	2000	500
ÇPA 8020060 MPT	800	2000	600
ÇPA 9018040 MPT	900	1800	400
ÇPA 9018050 MPT	900	1800	500
ÇPA 9018060 MPT	900	1800	600
ÇPA 9020040 MPT	900	2000	400
ÇPA 9020050 MPT	900	2000	500
ÇPA 9020060 MPT	900	2000	600

ÖN GÖRÜNÜŞ

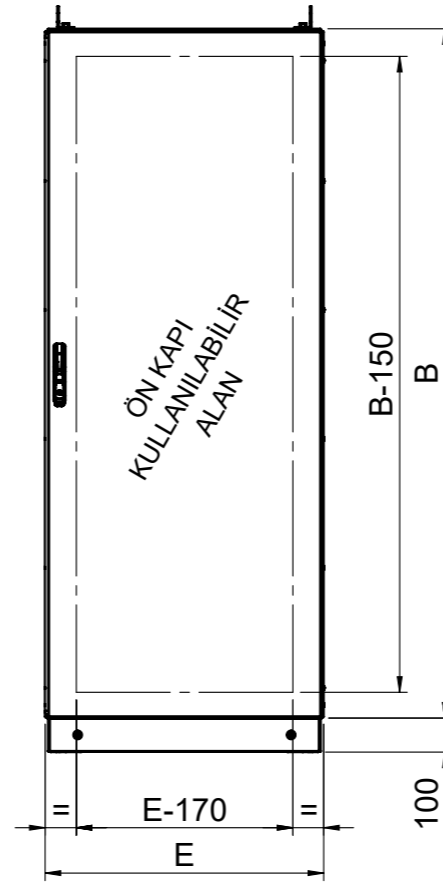

İÇ GÖRÜNÜŞ

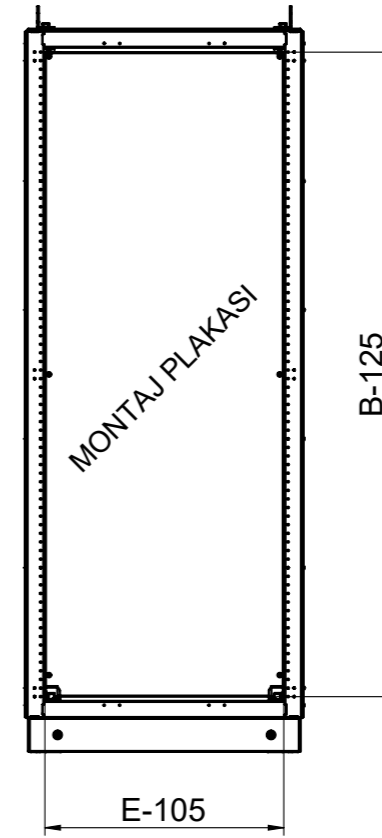

YAN GÖRÜNÜŞ

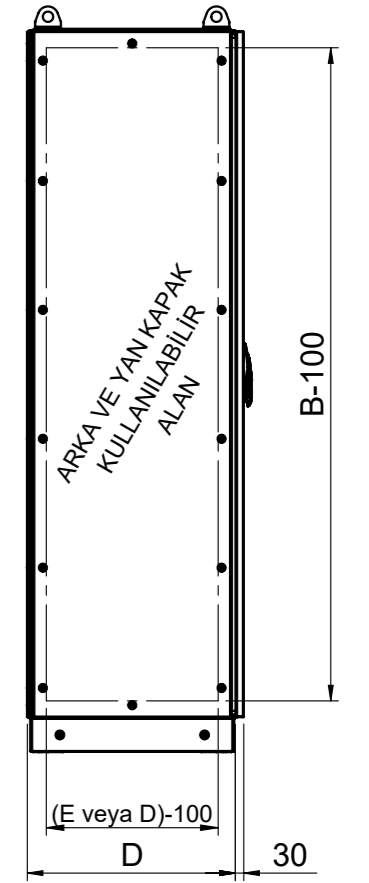

ÜST GÖRÜNÜŞ

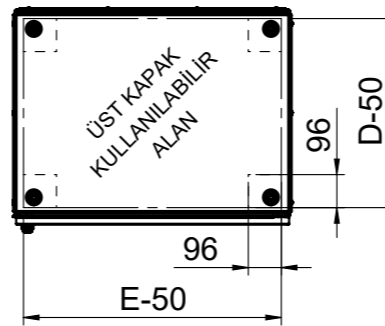

ALT GÖRÜNÜŞ

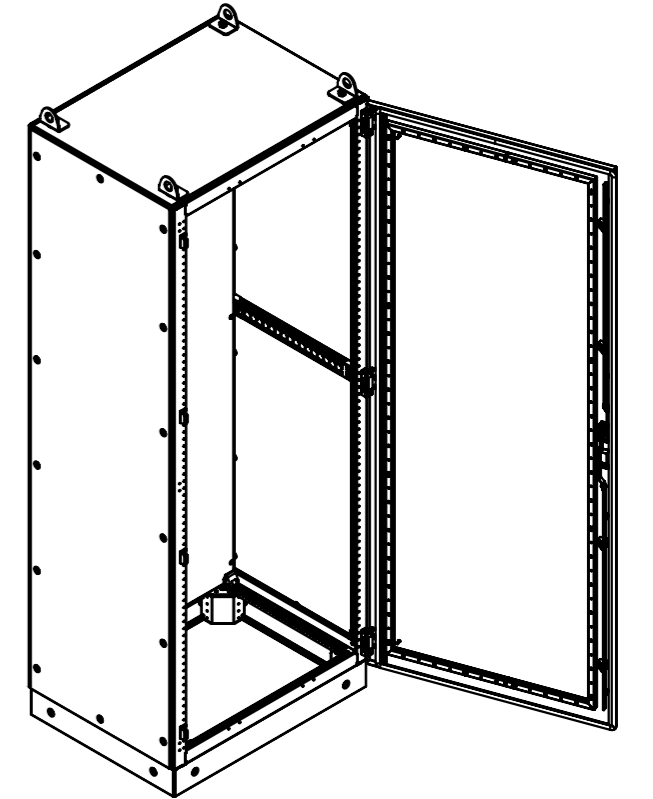
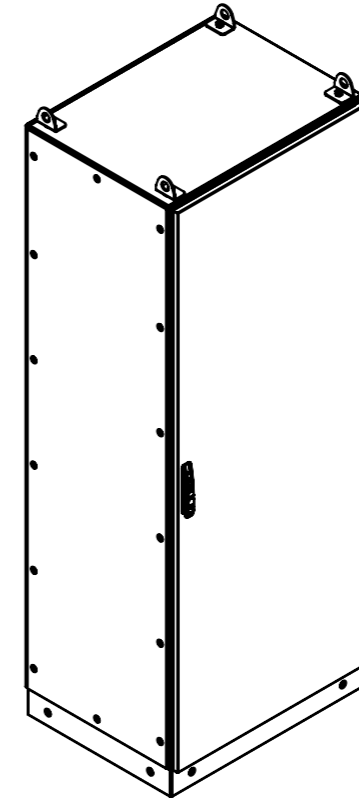
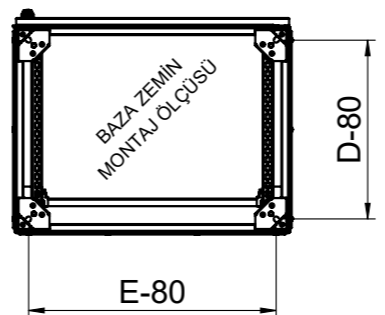

MALZEME / Material	KORUMA SINIFI / IP	DARBE DAYANIMI / IK	FİNAL / Finish
DKP	IP 41 - IP 55	IK 10	TOZ BOYA RAL 7035
ÇİZEN / Designed by	İSİM / Name	TARİH / Date	İMZA / Signature
KONTROL / Checked by	Nezhat ÖZTÜRK	15.11.2021	
ONAY / Approval	Fuat ATASOY	15.11.2021	
ÖLÇEK / Scale	REŞİM NO / DRAWING NUMBER	TANIM / DESCRIPTION	
1:22	A SERİSİ	MODÜLER DİKİLİ TİP MONTAJ PLAKALI PANOLAR	

