

A-A

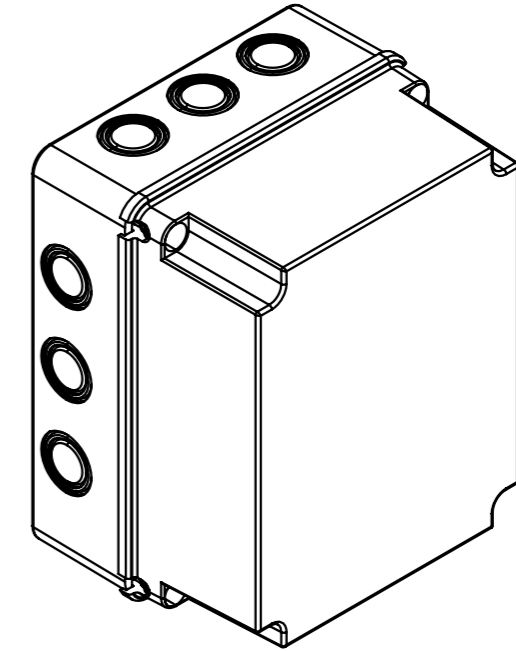

GENEL TOLERANSLAR DIN 7168	ÖLÇÜ TOLERANS	>0-6 ±0.1	>6-30 ±0.2	>30-120 ±0.3	>120-315 ±0.5	>315-1000 ±0.8	>1000-2000 ±1.2
-------------------------------	------------------	--------------	---------------	-----------------	------------------	-------------------	--------------------

MALZEME / Material	KALINLIK / Thickness	AĞIRLIK / Weight	YÜZEY ALANI / Surface Area	FİNAL / Finish
ABS	mm	0.7443 Kg	578916.872 m ²	-
ÇİZEN / Designed by	İSİM / Name	TARİH / Date	İMZA / Signature	
KONTROL / Checked by	Fuat ATASOY	14.11.2022		
ONAY / Approval	Fuat ATASOY	14.11.2022		
ÖLÇEK / Scale	REŞİM NO / DRAWING NUMBER	TANIM / DESCRIPTION		
1:4	ÇP 1473	SIVA ÜSTÜ BUAT (KIRMA YÜZEYLİ) (ŞEFFAF KAPAKLI) 250X200X160		

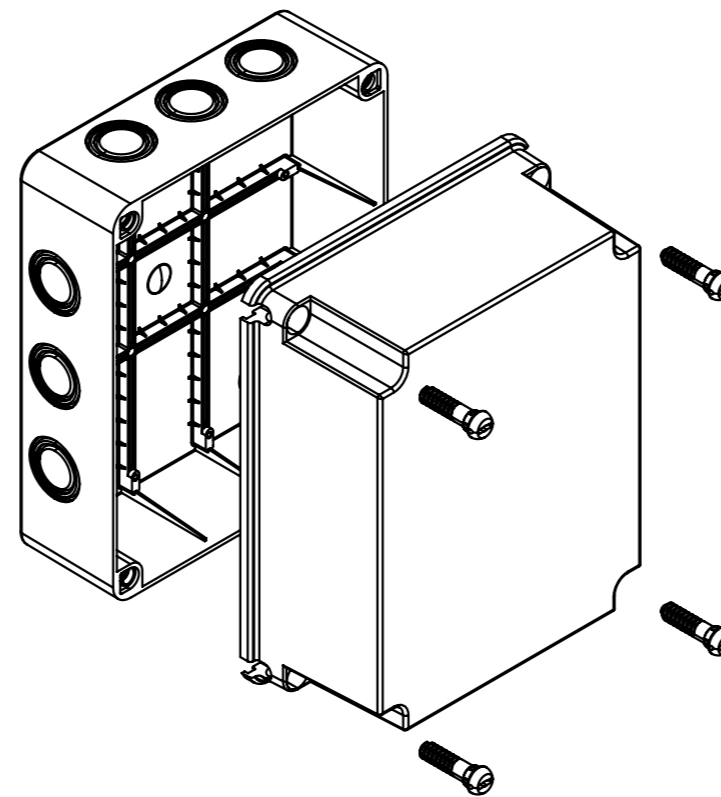

UYARI! Resim Üzerinden Ölçü Almayınız! / WARNING! Do Not Scale!