

A-A

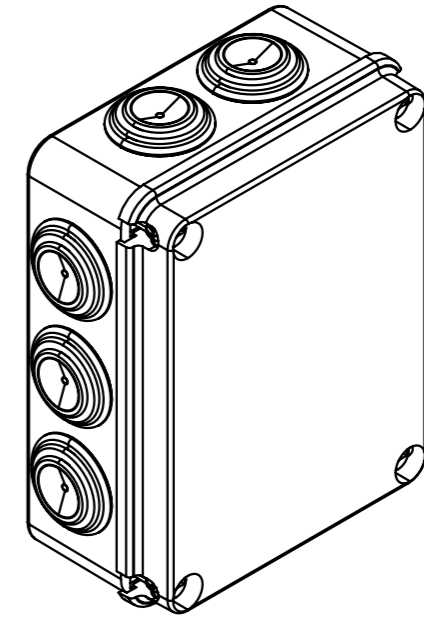

MALZEME / Material	KALINLIK / Thickness	AĞIRLIK / Weight	YÜZEY ALANI / Surface Area	FİNAL / Finish
ABS	mm	0.3321 Kg	328694.0122 m ²	-
ÇİZEN / Designed by	İSİM / Name	TARİH / Date	İMZA / Signature	
KONTROL / Checked by	Fuat ATASOY	15.11.2022		
ONAY / Approval	Fuat ATASOY	15.11.2022		
ÖLÇEK / Scale	REŞİM NO / DRAWING NUMBER	TANIM / DESCRIPTION		
1:3	ÇP 1052	SIVA ÜSTÜ BUAT (TIPALI) (OPAK KAPAKLI) 190X145X80		

GENEL TOLERANSLAR DIN 7168	ÖLÇÜ TOLERANS	>0-6 ±0.1	>6-30 ±0.2	>30-120 ±0.3	>120-315 ±0.5	>315-1000 ±0.8	>1000-2000 ±1.2
-------------------------------	------------------	--------------	---------------	-----------------	------------------	-------------------	--------------------

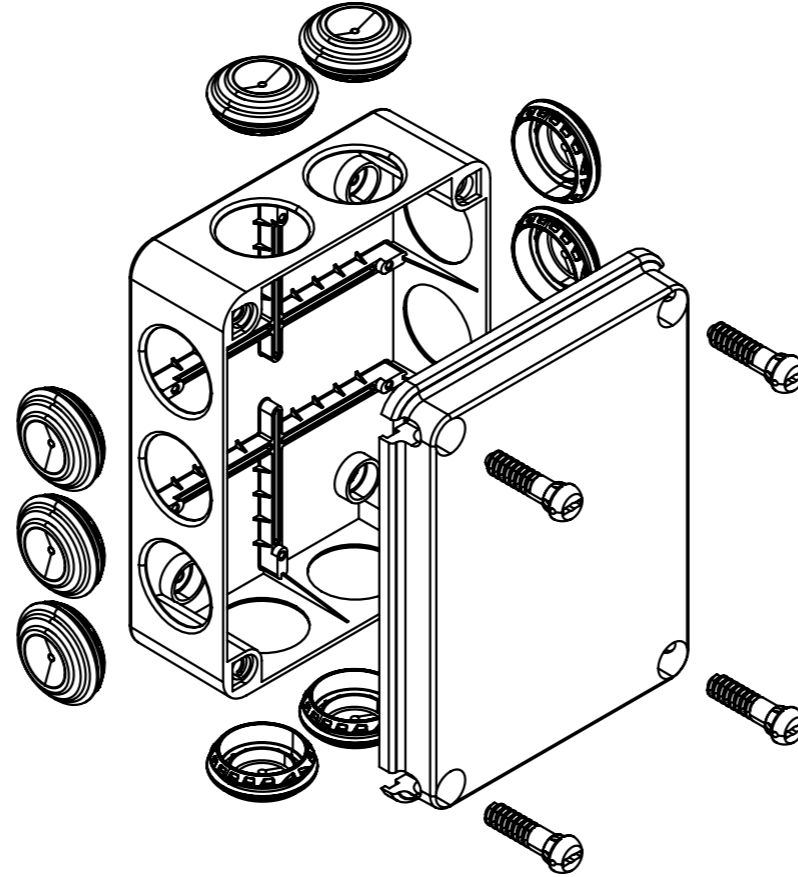